

User's Guide
AC Power Solutions
Agilent Models 6814B, 6834B, and 6843A

For instruments with Serial Numbers:

Agilent 6814B: 3601A-00101 through 00270
US36010101-up

Agilent 6834B: 3601A-00101 through 00140
US36010101-up

Agilent 6843A: 3540A-00101 through 00140
US35400101-up



Agilent Technologies

Agilent Part No. 5962-0887
Microfiche No 5962-0888

Printed in U.S.A.
December, 1998
Update April 2000

Warranty Information

CERTIFICATION

Agilent Technologies certifies that this product met its published specifications at time of shipment from the factory. Agilent Technologies further certifies that its calibration measurements are traceable to the United States National Bureau of Standards, to the extent allowed by the Bureau's calibration facility, and to the calibration facilities of other International Standards Organization members.

WARRANTY

This Agilent Technologies hardware product is warranted against defects in material and workmanship for a period of three years from date of delivery. Agilent Technologies software and firmware products, which are designated by Agilent Technologies for use with a hardware product and when properly installed on that hardware product, are warranted not to fail to execute their programming instructions due to defects in material and workmanship for a period of 90 days from date of delivery. During the warranty period Agilent Technologies will, at its option, either repair or replace products which prove to be defective. Agilent Technologies does not warrant that the operation for the software firmware, or hardware shall be uninterrupted or error free.

For warranty service, with the exception of warranty options, this product must be returned to a service facility designated by Agilent Technologies. Customer shall prepay shipping charges by (and shall pay all duty and taxes) for products returned to Agilent Technologies for warranty service. Except for products returned to Customer from another country, Agilent Technologies shall pay for return of products to Customer.

Warranty services outside the country of initial purchase are included in Agilent Technologies product price, only if Customer pays Agilent Technologies international prices (defined as destination local currency price, or U.S. or Geneva Export price).

If Agilent Technologies is unable, within a reasonable time to repair or replace any product to condition as warranted, the Customer shall be entitled to a refund of the purchase price upon return of the product to Agilent Technologies.

LIMITATION OF WARRANTY

The foregoing warranty shall not apply to defects resulting from improper or inadequate maintenance by the Customer, Customer-supplied software or interfacing, unauthorized modification or misuse, operation outside of the environmental specifications for the product, or improper site preparation and maintenance. NO OTHER WARRANTY IS EXPRESSED OR IMPLIED. AGILENT TECHNOLOGIES SPECIFICALLY DISCLAIMS THE IMPLIED WARRANTIES OF MERCHANTABILITY AND FITNESS FOR A PARTICULAR PURPOSE.

EXCLUSIVE REMEDIES

THE REMEDIES PROVIDED HEREIN ARE THE CUSTOMER'S SOLE AND EXCLUSIVE REMEDIES. AGILENT TECHNOLOGIES, INC. SHALL NOT BE LIABLE FOR ANY DIRECT, INDIRECT, SPECIAL, INCIDENTAL, OR CONSEQUENTIAL DAMAGES, WHETHER BASED ON CONTRACT, TORT, OR ANY OTHER LEGAL THEORY.

ASSISTANCE

The above statements apply only to the standard product warranty. Warranty options, extended support contacts, product maintenance agreements and customer assistance agreements are also available. Contact your nearest Agilent Technologies Sales and Service office for further information on Agilent Technologies' full line of Support Programs.

Safety Summary

The following general safety precautions must be observed during all phases of operation of this instrument. Failure to comply with these precautions or with specific warnings elsewhere in this manual violates safety standards of design, manufacture, and intended use of the instrument. Agilent Technologies assumes no liability for the customer's failure to comply with these requirements.

WARNING: LETHAL VOLTAGES

Ac sources can supply 425 V peak at their output. DEATH on contact may result if the output terminals or circuits connected to the output are touched when power is applied.

GENERAL

This product is a Safety Class 1 instrument (provided with a protective earth terminal). The protective features of this product may be impaired if it is used in a manner not specified in the operation instructions.

Any LEDs used in this product are Class 1 LEDs as per IEC 825-1.

ENVIRONMENTAL CONDITIONS

This instrument is intended for indoor use in an installation category III, pollution degree 2 environment. It is designed to operate at a maximum relative humidity of 95% and at altitudes of up to 2000 meters. Refer to the specifications tables for the ac mains voltage requirements and ambient operating temperature range.

BEFORE APPLYING POWER

Verify that the product is set to match the available line voltage, the correct fuse is installed, and all safety precautions are taken. Note the instrument's external markings described under "Safety Symbols".

GROUND THE INSTRUMENT

To minimize shock hazard, the instrument chassis and cover must be connected to an electrical ground. The instrument must be connected to the ac power mains through a grounded power cable, with the ground wire firmly connected to an electrical ground (safety ground) at the power outlet. Any interruption of the protective (grounding) conductor or disconnection of the protective earth terminal will cause a potential shock hazard that could result in personal injury.

ATTENTION: Un circuit de terre continu est essentiel en vue du fonctionnement sécuritaire de l'appareil. Ne jamais mettre l'appareil en marche lorsque le conducteur de mise ... la terre est d,branch,.

FUSES

Only fuses with the required rated current, voltage, and specified type (normal blow, time delay, etc.) should be used. Do not use repaired fuses or short-circuited fuseholders. To do so could cause a shock or fire hazard.

DO NOT OPERATE IN AN EXPLOSIVE ATMOSPHERE

Do not operate the instrument in the presence of flammable gases or fumes.

DO NOT REMOVE THE INSTRUMENT COVER

Operating personnel must not remove instrument covers. Component replacement and internal adjustments must be made only by qualified service personnel.

DO NOT EXCEED INPUT RATINGS

Operation at line voltages or frequencies in excess of those stated on the line rating label may cause leakage currents in excess of 5.0 mA peak.

Instruments that appear damaged or defective should be made inoperative and secured against unintended operation until they can be repaired by qualified service personnel.

SAFETY SYMBOLS



Direct current



Alternating current



Both direct and alternating current



Three-phase alternating current



Earth (ground) terminal



Protective earth (ground) terminal



Frame or chassis terminal



Terminal is at earth potential. Used for measurement and control circuits designed to be operated with one terminal at earth potential.



Terminal for Neutral conductor on permanently installed equipment



Terminal for Line conductor on permanently installed equipment



On (supply)



Off (supply)



Standby (supply). Units with this symbol are not completely disconnected from ac mains when this switch is off. To completely disconnect the unit from ac mains, either disconnect the power cord or have a qualified electrician install an external switch.



In position of a bi-stable push control



Out position of a bi-stable push control



Caution, risk of electric shock



Caution, hot surface



Caution (refer to accompanying documents)

WARNING

The WARNING sign denotes a hazard. It calls attention to a procedure, practice, or the like, which, if not correctly performed or adhered to, could result in personal injury. Do not proceed beyond a WARNING sign until the indicated conditions are fully understood and met.

Caution

The CAUTION sign denotes a hazard. It calls attention to an operating procedure, or the like, which, if not correctly performed or adhered to, could result in damage to or destruction of part or all of the product. Do not proceed beyond a CAUTION sign until the indicated conditions are fully understood and met.

Declaration Page

DECLARATION OF CONFORMITY

according to ISO/IEC Guide 22 and EN 45014

Manufacturer's Name: Agilent Technologies, Inc.
Manufacturer's Address: 140 Green Pond Road
Rockaway, New Jersey 07866
U.S.A.

declares that the Product

Product Name: a) AC Power Source/Analyzer
b) Harmonic/Flicker Test System

Model Number(s): a) Agilent 6814A, 6814B, 6834A, 6834B
b) Agilent 6843A

conforms to the following Product Specifications:

Safety: IEC 1010-1:1990+A1(1992) / EN 61010-1:1993

EMC: CISPR 11:1990 / EN 55011:1991 - Group 1 Class A
IEC 801-2:1991 / EN 50082-1:1992 - 4 kV CD, 8 kV AD
IEC 801-3:1984 / EN 50082-1:1992 - 3 V / m
IEC 801-4:1988 / EN 50082-1:1992 - 0.5 kV Signal Lines
1 kV Power Lines

Supplementary Information:

The product herewith complies with the requirements of the Low Voltage Directive 73/23/EEC and the EMC Directive 89/336/EEC and carries the CE-marking accordingly.

New Jersey
Location

January 1997
Date



Bruce Krueger / Quality Manager

European Contact: Your local Agilent Sales and Service Office or Agilent GmbH,
Department TRE, Herrenberger Strasse 130, D-71034 Boeblingen (FAX:+49-7031-14-3143)

Acoustic Noise Information

Herstellerbescheinigung

Diese Information steht im Zusammenhang mit den Anforderungen der Maschinenläminformationsverordnung vom 18 Januar 1991.

- * Schalldruckpegel $L_p < 70$ dB(A)
- * Am Arbeitsplatz
- * Normaler Betrieb
- * Nach EN 27779 (Typprüfung).

Manufacturer's Declaration

This statement is provided to comply with the requirements of the German Sound Emission Directive, from 18 January 1991.

- * Sound Pressure $L_p < 70$ dB(A)
- * At Operator Position
- * Normal Operation
- * According to EN 27779 (Type Test).

Printing History

The edition and current revision of this manual are indicated below. Reprints of this manual containing minor corrections and updates may have the same printing date. Revised editions are identified by a new printing date. A revised edition incorporates all new or corrected material since the previous printing date.

Changes to the manual occurring between revisions are covered by change sheets shipped with the manual. In some cases, the manual change applies only to specific instruments. Instructions provided on the change sheet will indicate if a particular change applies only to certain instruments.

This document contains proprietary information protected by copyright. All rights are reserved. No part of this document may be photocopied, reproduced, or translated into another language without the prior consent of Agilent Technologies. The information contained in this document is subject to change without notice.

© Copyright 1996, 1998 Agilent Technologies, Inc.

Edition 1 _____ January, 1996
Edition 2 _____ December, 1998
Update _____ April, 2000

Table of Contents

Warranty Information	2
Safety Summary	3
Declaration Page	5
Acoustic Noise Information	6
Printing History	6
Table of Contents	7
1. GENERAL INFORMATION	9
Document Orientation	9
Safety Considerations	10
Options, Accessories, and User Replaceable Parts	10
Description	10
Capabilities	11
Front Panel/Remote Operation	12
Output Characteristic	12
Ranges	12
Output VA Capability	13
2. INSTALLATION	15
Inspection	15
Damage	15
Packaging Material	15
Items Supplied	15
Cleaning	15
Location	16
Bench Operation	16
Rack Mounting	16
Input Connections	16
Input Source and Line Fuse	17
Installing the Power Cord	17
Output Connections	18
Wire Considerations	19
Voltage Drops	19
Remote Sense Connections	20
OVP Considerations	21
Output Rating	21
Trigger Connections	21
Digital Connections	21
Controller Connections	22
GPIB Connector	22
RS-232 Interface	23
3. TURN-ON CHECKOUT	25
Introduction	25
Preliminary Checkout	25
Using the Keypad	26
Checkout Procedure	26
In Case of Trouble	29
Error Messages	29
Line Fuse	29

4. FRONT PANEL OPERATION	31
Introduction	31
Front Panel Description	31
System Keys	33
Function Keys	34
Immediate Action Keys	34
Scrolling Keys	35
Meter Display Keys	35
Output Control Keys	36
Protection and Status Control Keys	38
Trigger and List Control Keys	39
Entry Keys	40
Examples of Front Panel Programming	41
1 - Setting the Output Voltage Amplitude	41
Procedure for Three-Phase AC Sources	42
2 - Setting the Output Frequency	43
3 - Setting a Protection Feature	43
4 - Using Transient Voltage Modes	44
5 - Trigger Delays and Phase Synchronization	47
6 - Using Slew Rates to Generate Waveforms	50
7 - Measuring Peak Inrush Current	52
8 - Setting the GPIB Address and RS-232 Parameters	53
9 - Saving and Recalling Operating States	53
10 - Switching Between Single- and Three-phase Operation (Agilent 6834B only)	54
A. SPECIFICATIONS	55
Specifications	55
Supplemental Characteristics	56
B. VERIFICATION AND CALIBRATION	59
Introduction	59
Equipment Required	59
Test Setup	60
Performing the Verification Tests	60
Turn-On Checkout Procedure	60
Voltage Programming and Measurement Accuracy	61
RMS Current Readback Accuracy	61
Performing the Calibration Procedure	62
Front Panel Calibration Menu	63
Front Panel Calibration	63
Enable Calibration Mode	63
Calibrating and Entering Voltage Calibration Values	64
Calibrating and Entering Current Calibration Values	65
Calibrating the Output Impedance (Agilent 6843A only)	66
Saving the Calibration Constants	66
Changing the Calibration Password	66
Calibration Error Messages	67
Calibration Over the GPIB	67
Agilent Calibration Program Listing	67
C. ERROR MESSAGES	71
Error Number List	71
INDEX	75

General Information

Document Orientation

This manual describes the operation of the Agilent Technologies 6814B/6834B/6843A AC Power Solutions. These units will be referred to as "ac sources" throughout this manual. Operation of the Agilent 6843A is described for normal mode operation only. The following documents are shipped with your ac source:

- ◆ a Quick-Start Guide, to help you quickly get started using the ac source
- ◆ a User's Guide, containing detailed installation, checkout, and front panel information
- ◆ a Programming Guide, containing detailed GPIB programming information
- ◆ a Quick Reference Card, designed as a memory jogger for the experienced user
- ◆ Regulatory Test Solution User's Guides are shipped with Agilent 6843A units only

You will find information on the following tasks in these guides. Refer to the table of contents of each guide for a complete list of the topics.

Topic	Location
Accessories and options	Chapter 1 - this guide
Calibrating the ac source	Appendix B - this guide
Front panel keys	Chapter 4 - this guide
Front panel programming examples	Chapter 4 - this guide
Line voltage connections	Chapter 2 - this guide
Line voltage ratings	Appendix A - this guide
Operator replaceable parts	Chapter 1 - this guide
Operator troubleshooting	Chapter 3 - this guide
Operating characteristics	Appendix A - this guide
Performance specifications	Appendix A - this guide
Quick operating checkout	Chapter 3 - this guide
Rack mounting	Chapter 2 - this guide
RS-232 operation	Chapter 2 - this guide
SCPI programming examples	Chapter 3 - Programming Guide
SCPI programming commands	Chapter 4 - Programming Guide
Turn-on/checkout	Chapter 3 - this guide
Wiring - discrete fault indicator (DFI)	Chapter 2 - this guide
- GPIB controller	Chapter 2 - this guide
- load or loads	Chapter 2 - this guide
- voltage sensing (local and remote)	Chapter 2 - this guide
- remote inhibit (RI)	Chapter 2 - this guide

Safety Considerations

This ac source is a Safety Class 1 instrument, which means it has a protective earth terminal. That terminal must be connected to earth ground through a power source equipped with a ground receptacle. Refer to the Safety Summary page at the beginning of this guide for general safety information. Before installation or operation, check the ac source and review this guide for safety warnings and instructions. Safety warnings for specific procedures are located at appropriate places in the guide.

Options, Accessories, and User Replaceable Parts

Table 1-1. Options

Option	Description
400	Input power 360-440 Vac, three-phase, 47-63 Hz
1CM	2- Rack mount kit (Agilent 5062-3977) Support rails (Agilent 5064-0001) are required (rails are not included in rack mount kit).

Table 1-2. Accessories

Item	Agilent Part Number
Fuse replacement kits	
30AM for 180-235 Vac, 3-phase line	5060-3513
GPIB cables	
0.5 meters (1.6 ft)	10833D
1.0 meter (3.3 ft)	10833A
2.0 meters (6.6 ft)	10833B
3.0 meters (13.2 ft)	10833C
Heavy duty slide mount kit	5063-2310

Table 1-3. User Replaceable Parts List

Description	Agilent Part No.
Rack mount kit	See "Options"
Slide mount kit	See "Accessories"
7-terminal sense connector plug	1252-3698
Sense connector cover	4040-2268
4-terminal digital connector plug	1252-1488
AC input safety cover (with strain relief and brushing)	5001-9837
Screw (4), ac input safety cover (6-32 x 1.5in)	2360-0405
Screw (8), ac input barrier block (8-32 x 5/16in)	N/A
AC output safety cover	5001-9811
Screw (2), ac output safety cover (6-32 x .3in)	2460-0012
Screw (8), ac output barrier block (10-32 x .37in)	N/A
Fuse safety cover	5001-9810
Screw (2), fuse safety cover (6-32 x .3in)	2460-0012
User's Guide (this manual)	5962-0887
Programming Guide	5962-0889
Quick Start Guide	5962-0883
Quick Reference Card	5962-0885
Appropriate Agilent Regulatory Test Solution Software	Agilent 14761A, 14762A, 14763A

Description

The ac source combines three instruments in one unit as shown in the following figure. The function generator produces waveforms with programmable amplitude, frequency, and shape. The power amplifier amplifies the function generator signal to produce the ac power for your application. The measurement functions range from a simple readback of rms voltage and current, to sophisticated capabilities such as waveform analysis.

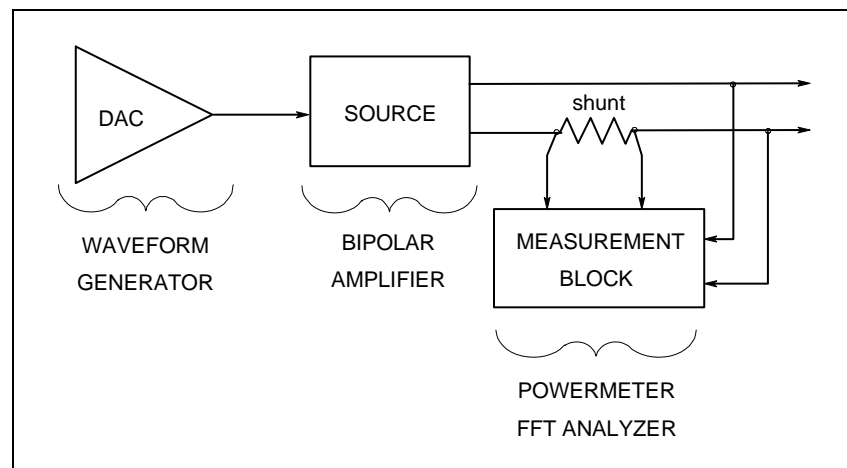

Figure 1-1. AC Source Functional Elements

The following model ac power sources are described in this User's Guide:

Model	Description
Agilent 6814B	3000 VA single –phase operation
Agilent 6834B	1500 VA/ phase for three-phase operation (4500 VA for single-phase operation)
Agilent 6843A	4500 VA single-phase operation

Capabilities

- ◆ Programmable ac voltage, dc voltage, frequency, phase, and current limit.
- ◆ Sine, square, clipped sine, and user-definable waveforms.
- ◆ Voltage and frequency slew control.
- ◆ Synthesized waveform generation for high resolution and accuracy in frequency, low waveform distortion, and glitch-free phase transitions.
- ◆ Step and pulse output transients for generating surge, sag, dropout, and other line disturbance simulations.
- ◆ Nonvolatile list programming for generating complex output transients or test sequences.
- ◆ Three-phase/single-phase output capability (Agilent 6834B only)
- ◆ Extensive measurement capability:
 - Ac rms, dc, ac+dc voltage and current and peak current.
 - Real, reactive, and apparent power.
 - Harmonic analysis of voltage and current waveforms gives amplitude, phase, and total harmonic distortion results up to the 50th harmonic.
 - Triggered acquisition of digitized voltage and current with extensive post-acquisition calculations.

1 - General Information

- Additional total power and neutral current measurements in the three-phase model.
- All measurements made with 16-bit resolution.
- ◆ Trigger In and Trigger Out for synchronizing transient events or measurements with external signals.
- ◆ Front panel control with 14-character vacuum fluorescent display, keypad, and rotary pulse generators for voltage and frequency settings.
- ◆ Built-in GPIB and RS-232 interface programming with SCPI command language.
- ◆ Nonvolatile state and waveform storage and recall.
- ◆ Over-voltage, over-power, over-current, over-temperature, and RI/DFI protection features.
- ◆ Built-in output and sense disconnect relays.
- ◆ Extensive selftest, status reporting, and software calibration.

Front Panel/Remote Operation

The front panel has both rotary (RPG) and keypad controls for setting the output voltage and frequency. The panel display provides digital readouts of a number of output measurements. Annunciators display the operating status of the ac source. System keys let you perform system functions such as setting the GPIB address and recalling operating states. Front panel Function keys access the ac source function menus. Front panel Entry keys let you select and enter parameter values. Refer to Chapter 4 for a complete description of the front panel controls.

Remotely programming is accomplished from either the GPIB bus or from an RS-232 serial port. GPIB and RS-232 programming uses SCPI commands (Standard Commands for Programmable Instruments) that make the ac source programs compatible with those of other instruments. AC source status registers permit remote monitoring of a wide variety of ac source operating conditions

NOTE: Refer to the ac source Programming Guide for further information about remotely programming the ac source. If you are using the Agilent 6843A, refer to the appropriate Regulatory Test Solution User's Guide for information about regulatory testing.

Output Characteristic

Ranges

The ac source's output characteristic is shown in the following figure. The output voltage of the ac source may be adjusted to any value within the range of the unit. On three-phase units, each phase can be adjusted independently of the other two.

Rated output VA and conversion efficiency is greatest when the output voltage is set near maximum. For this reason, the ac source is designed to operate on one of two ranges: 150 volts full-scale, or 300 volts full-scale. You should choose the range that allows you to operate nearest the full-scale output capability of the selected range.

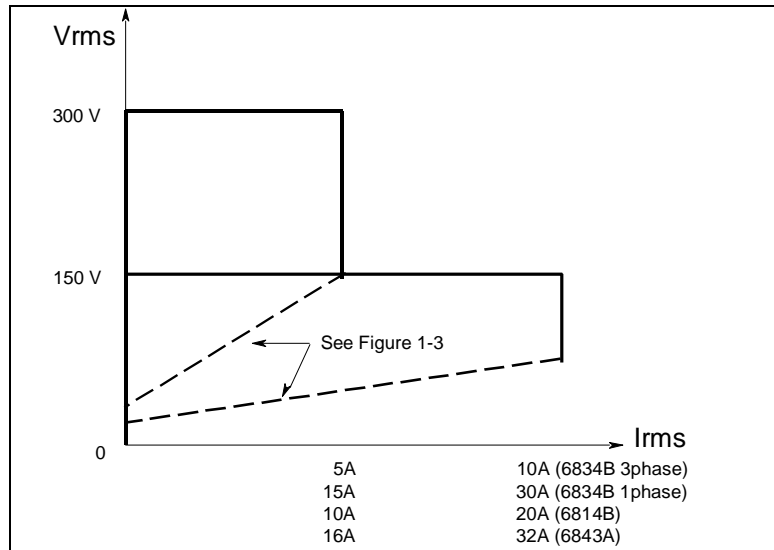

Figure 1-2. AC Source Output Characteristic (in real-time mode)

Output VA Capability

The output capability of each output phase is limited by VA (volts-amps) rather than power (watts). The amount of VA available to a load can be determined by examining figure 1-3, the output power curve. This curve rates the available VA versus output voltage. Full VA is available only at a full-scale voltage. Full current is available at voltages between 50% and 100% of the output voltage range. Appendix A documents the ac source’s specifications and supplemental characteristics.

NOTE: The load on the ac source may draw full VA at any power factor between 0 and 1, and may draw maximum current with a crest factor of 4 (3 for Agilent 6843A). If the load draws current in excess of the maximum rated rms or peak current, the voltage amplitude will be clipped to prevent excessive internal power dissipation.

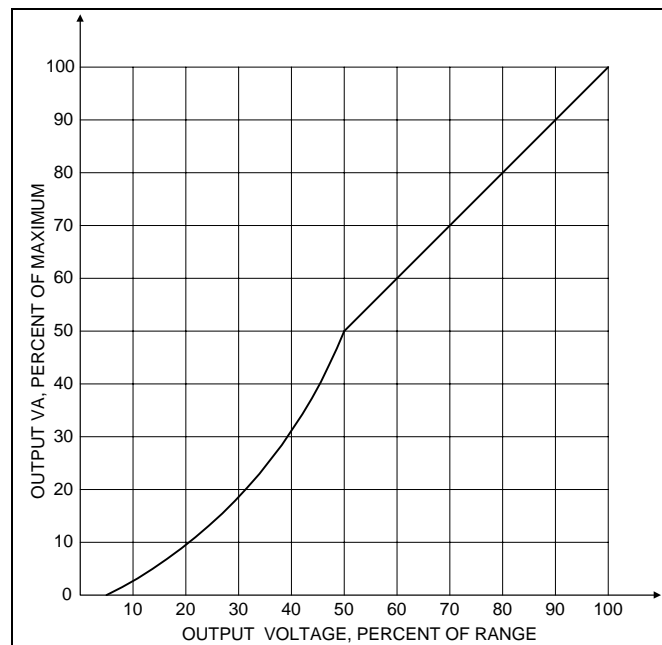

Figure 1-3. AC Source VA Capabilities

Installation

Inspection

Damage

When you receive your ac source, inspect it for any obvious damage that may have occurred during shipment. If there is damage, notify the shipping carrier and the nearest Agilent Sales and Support Office immediately. The list of Agilent Sales and Support Offices is at the back of this guide. Warranty information is printed in the front of this guide.

Packaging Material

Until you have checked out the ac source, save the shipping carton and packing materials in case the unit has to be returned. If you return the ac source for service, attach a tag identifying the model number and the owner. Also include a brief description of the problem.

Items Supplied

Check that the following items are included with your ac source. Some items are installed in the unit.

Power Cord	A power cord appropriate for your location. The cord may or may not be terminated in a power plug (see "Options" in Chapter 1). If the cord is not included, contact your nearest Agilent Sales and Support Offices (refer to the list at the back of this guide).
Sense/Digital connector	a 4-terminal digital plug that connects to the back of the unit. a 7-terminal sense plug that connects to the back of the unit.
Safety covers	Ac input cover with strain relief Ac output cover Fuse cover
Manuals	<i>User's Guide</i> <i>Programming Guide</i> <i>Quick Start Guide</i> <i>Quick Reference Card</i> <i>Regulatory Test Solutions Guides (supplied with Agilent 6843A units)</i>
Change page	If applicable, change sheets may be included with this guide. If there are change sheets, make the indicated corrections in this guide.

Cleaning

Use a dry cloth or one slightly dampened with water to clean the external case parts. Do not attempt to clean internally.

WARNING: To prevent electric shock, unplug the unit before cleaning.

Location

Refer to the Safety Summary page at the beginning of this manual for safety-related information about environmental conditions.

WARNING: Agilent 6814B units weigh 79.5 kg (175 lbs.)
Agilent 6834B/ 6843A units weigh 87.7 kg (193 lbs.)
Obtain adequate help when moving the unit or mounting the unit in the rack.

Bench Operation

The outline diagram in figure 2-1 gives the dimensions of your ac source. The feet may be removed for rack mounting. Your ac source must be installed in a location that allows sufficient space at the sides and back of the unit for adequate air circulation. Minimum clearances are 1 inch (25 mm) along the sides. **Do not block the fan exhaust at the rear of the unit.**

Rack Mounting

The ac source can be mounted in a standard 19-inch rack panel or cabinet. Rack mounting kits are available as Option 1CM or 1CP. Installation instructions are included with each rack mounting kit

CAUTION: Agilent 6814B/ 6834B/ 6843A units require instrument support rails for non-stationary installations. These are normally ordered with the cabinet and are not included with the rack mounting kits.

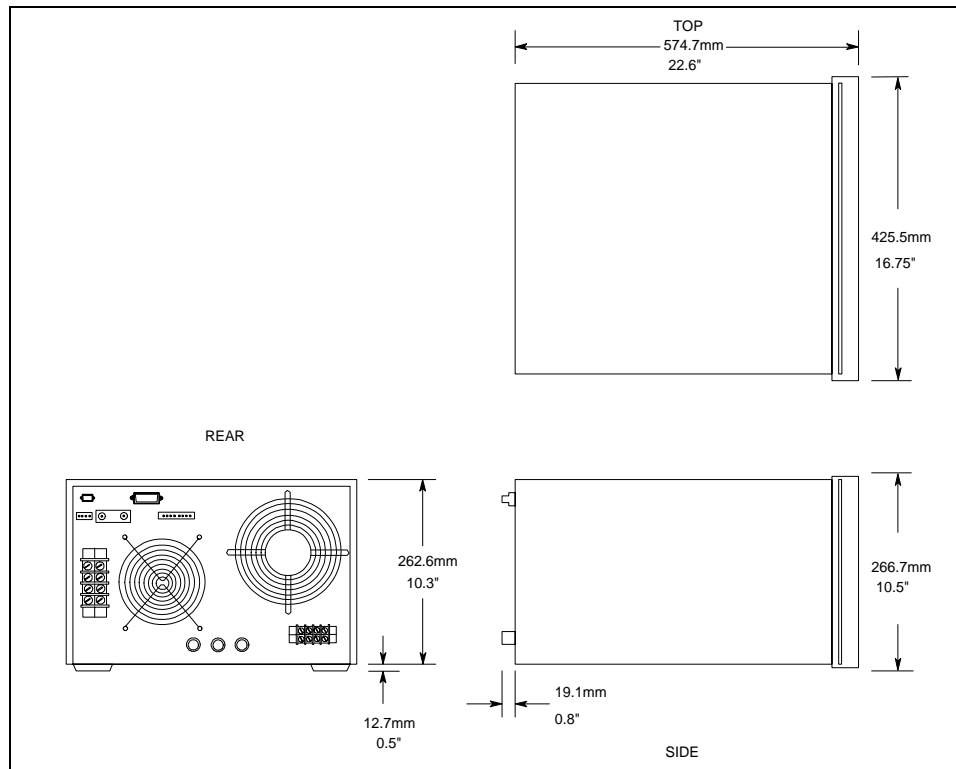

Figure 2-1. Outline Diagram

Input Connections

Input Source and Line Fuse

The ac source requires a 3-phase power service that provides 7350 VA (6000 W) maximum. The power service should have a current rating greater than or equal to the ac source's circuit breaker rating. The ac source has a delta input (no neutral connection) and will accept power from either delta (triangle) or wye (star) services.

CAUTION: Two input voltage ranges are available (see "AC Input Ratings" in appendix A). The ac source will be damaged if it is operated at an input voltage that is outside of its configured input range.

*In order to maintain phase current balancing, the power service should be a dedicated line with only Agilent 6814B/6834B/6843A ac sources drawing current from it. A disconnect box located near the ac source is recommended for all installations and is **mandatory** for direct-wired installations.*

Installing the Power Cord

WARNING: Installation of the power cord must be done by a qualified and licensed electrician and must be in accordance with local electrical codes.

The power cords supplied with the ac source do not include a power plug. Terminating connectors and a ground lug are attached to one end of the cord. See Figure 2-2 while performing the following procedure.

1. Check the line fuses as follows:
 - a. Examine the **FUSES** label on the rear panel.
 - b. Remove the safety cover in front of the fuse caps.
 - c. Unscrew the line fuse caps from the rear panel and verify that all fuses are as specified on the label. Reinstall the fuses.
 - d. Reinstall the safety cover in front of the fuse caps.
2. Remove the ac input cover from the back of the unit.
3. Open the line clamp on the ac input cover and insert the line cord through the opening.
4. Position the power cord so that the clamp is near the end of the outside insulating sheath on the power cord. Tighten the screws to secure the clamp.
5. Secure the three ac lines to the ac power strip as follows:
 - Phase 1 to **L1** (black).
 - Phase 2 to **L2** (red).
 - Phase 3 to **L3** (orange).
6. Secure the ground wire (green) to the chassis earth ground terminal.
7. Slip the safety cover over the ac input terminal strip and secure the cover with the four screws.
8. If required, wire the appropriate power plug to the other end of the power cord. For user-made cables, strip back the sheath 10 cm (4 in).

2 - Installation

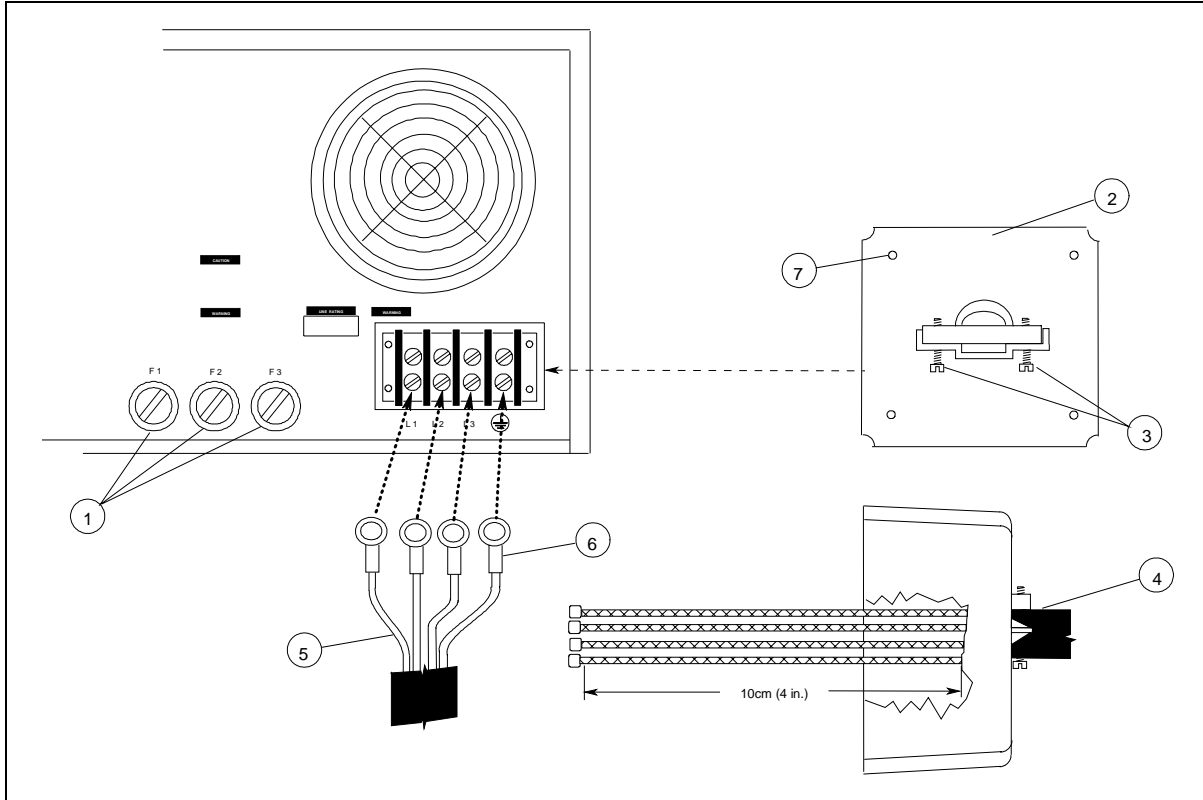

Figure 2-2. Connecting the Power Cord

Output Connections

The power output terminal block has a termination for each of the output phases ($\phi 1$, $\phi 2$, $\phi 3$) and a floating neutral line (COM) for the phase return connections. A separate earth ground terminal (\perp) is located near the output terminals.

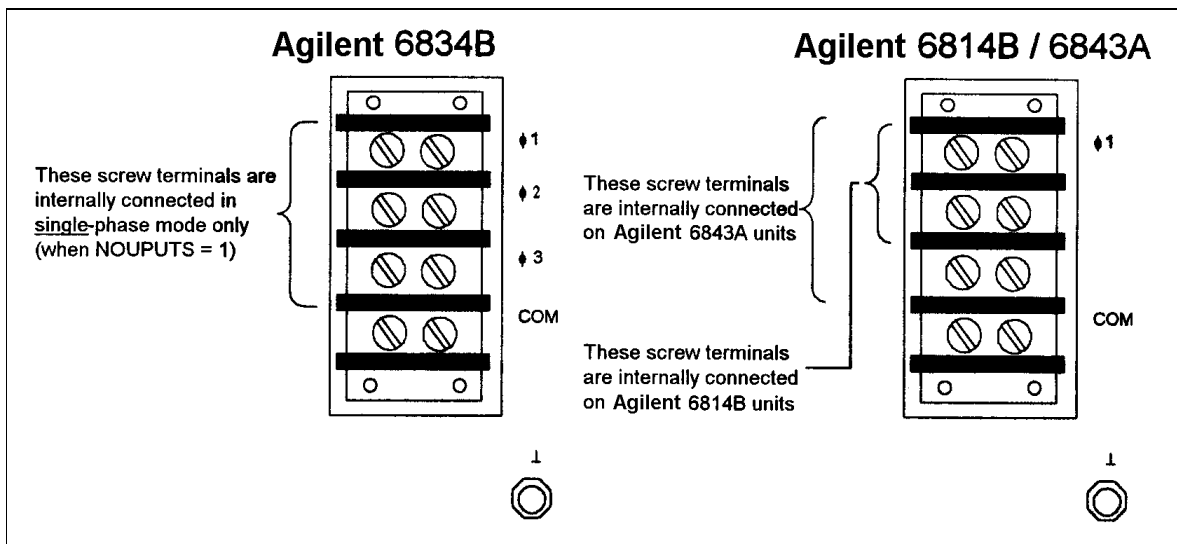

Figure 2-3. Output Connections

NOTE: To minimize the possibility of instability on the output, keep load leads as short as possible bundle or twist the leads tightly together to minimize inductance

Wire Considerations

Current Ratings

Fire Hazard To satisfy safety requirements, load wires must be large enough not to overheat when carrying the maximum short-circuit current of the ac source. If there is more than one load, then any pair of load wires must be capable of safely carrying the full-rated current of the ac source.

Table 2-1 lists the characteristics of AWG (American Wire Gage) copper wire.

Table 2-1. Ampacity and Resistance of Stranded Copper Conductors

AWG No.	Ampacity ¹	Resistance ² (Ω /m)	AWG No.	Ampacity ¹	Resistance ² (Ω /m)
14	25	0.0103	6	80	0.0016
12	30	0.0065	4	105	0.0010
10	40	0.0041	2	140	0.00064
8	60	0.0025	1/0	195	0.00040

NOTES:

1. Ampacity is based on 30°C ambient temperature with conductor rated at 60°C. For ambient temperature other than 30°C, multiply the above ampacities by the following constants:

Temp. (°C)	Constant	Temp. (°C)	Temp. (°C)
21-25	1.08	41-45	0.71
26-30	1.00	46-50	0.58
31-35	0.91	51-55	0.41
36-40	0.82		

2. Resistance is nominal at 75 °C wire temperature.

Voltage Drops

The load wires must also be large enough to avoid excessive voltage drops due to the impedance of the wires. In general, if the wires are heavy enough to carry the maximum short circuit current without overheating, excessive voltage drops will not be a problem. The voltage drops across the load wires should be limited to less than 2% of the output voltage.

Refer to Table 2-1 if you need to calculate the voltage drop for some commonly used AWG copper wire.

Remote Sense Connections

Under normal operation, the ac source senses the output voltage at the output terminals on the back of the unit. External sense terminals are available on the **back** of the unit that allow the output voltages to be sensed at the load, compensating for impedance losses in the load wiring. As shown in the following figure:

- ◆ Connect the phase 1 ($\phi 1$) through phase 2 (ϕ) sense terminals to the side of the load that connects to the corresponding output terminal.
- ◆ Connect the Neutral (COM) sense terminal connector to the neutral side of the load.
- ◆ Twist and shield all signal wires to and from the sense connectors.

The sense leads are part of the ac source's feedback path and must be kept at a low resistance in order to maintain optimal performance. Connect the sense leads carefully so that they do not become open-circuited. If the sense leads are left unconnected or become open during operation, the ac source will regulate at the output terminals, resulting in a 3% to 5% increase in output over the programmed value.

Set the ALC command to EXT (external) to enable remote sensing. The ALC command is located under the **Voltage** key as explained in Chapter 4. Set the ALC command to INT (internal) to disable remote sensing.

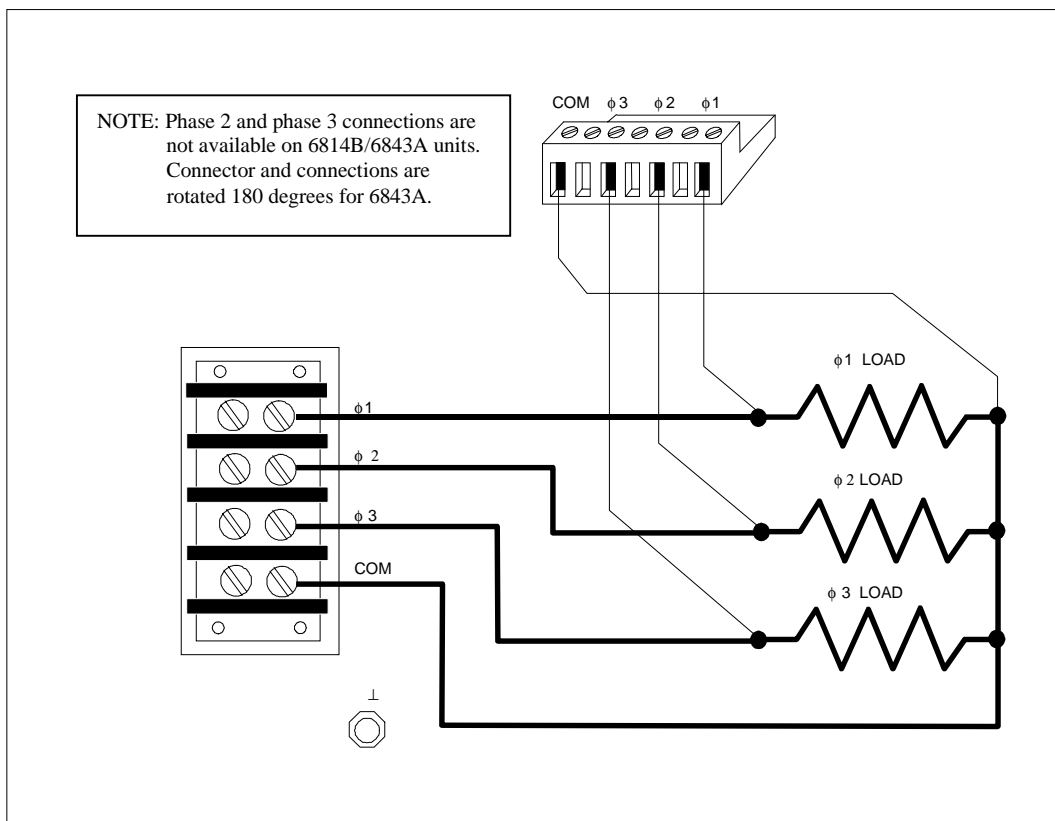

Figure 2-4. Remote Sense Connections

OVP Considerations

The overvoltage protection circuit senses voltage near the output terminals, not at the load. Therefore the signal sensed by the OVP circuit can be significantly higher than the actual voltage at the load. When using remote sensing, you must program the OVP trip voltage high enough to compensate for the voltage drop between the output terminals and the load.

Output Rating

In remote sense applications, the voltage drop in the load leads subtracts from the available load voltage (see "Remote Sensing Capability" in appendix A). As the ac source increases its output to overcome this voltage drop, the sum of the programmed voltage and the load-lead drop may exceed the ac source's maximum voltage rating. This will not damage the unit, but may trip the OV protection circuit, which senses the voltage at the output terminals.

Trigger Connections

The BNC trigger connectors on the rear panel let you apply trigger signals to the ac source as well as generate trigger signals from the ac source. The electrical characteristics of the trigger connectors are described in appendix A. More information on programming external triggers is found in Chapter 4 of the ac source Programming Guide.

Trigger IN Allows negative-going external trigger signals to trigger the ac source.
Trigger OUT Generates a negative-going pulse when the selected transient output has occurred.

Digital Connections

This connector, which is on the rear panel, is for connecting the fault and the inhibit signals. The fault (FLT) signal is also referred to as the DFI signal in the front panel and SCPI commands. The inhibit (INH) signal is also referred to as the RI signal in the front panel and SCPI commands.

The connector accepts wires sizes from AWG 22 to AWG 12. Disconnect the mating plug to make your wire connections. The electrical characteristics of the digital connectors are described in appendix A. More information on programming the digital connectors is found in Chapter 4 of the ac source Programming Guide.

NOTE: It is good engineering practice to twist and shield all signal wires to and from the digital connectors

The following examples show how you can connect the FLT/INH circuits of the ac source.

In example A, the INH input connects to a switch that shorts pin + to pin \perp whenever it is necessary to disable output of the unit. This activates the remote inhibit (RI) circuit, which turns off the ac output. The front panel Prot annunciator comes on and the RI bit is set in the Questionable Status Event register. To re-enable the unit, first open the connection between pins + and \perp and then clear the protection circuit. This can be done either from the front panel or over the GPIB /RS-232.

2 - Installation

In example B, the FLT output of one unit is connected to the INH input of another unit. A fault condition in one of the units will disable all of them without intervention either by the controller or external circuitry. The controller can be made aware of the fault via a service request (SRQ) generated by the Questionable Status summary bit.

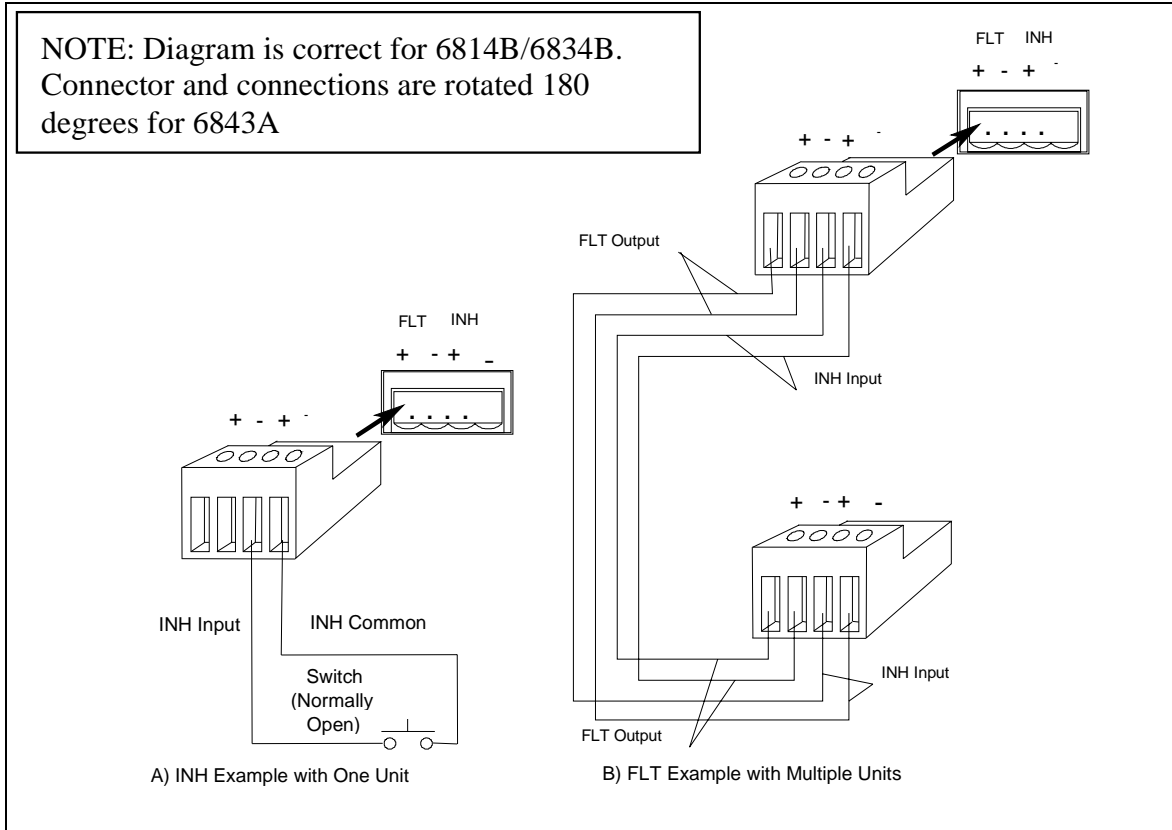

Figure 2-5. FLT/INH Examples

Controller Connections

The ac source connects to a controller either through a GPIB or an RS-232 connector.

GPIB Connector

Each ac source has its own GPIB bus address. AC sources may be connected to the bus in series configuration, star configuration, or a combination of the two. You may connect from 1 to 15 ac sources to a controller GPIB interface.

NOTE: The ac source is shipped from the factory with its GPIB address set to 5. This address can be changed as described in Chapter 4 of this guide.

RS-232 Interface

The ac source provides an RS-232 programming interface, which is activated by commands located under the front panel **Address** key. When the RS-232 interface is selected, the GPIB interface is disabled.

NOTE: Sending or receiving data over the RS-232 interface when not configured for REMOTE operation can cause unpredictable results. Always make sure the ac source is configured for remote operation when using the RS-232 interface.

Interface Commands

All SCPI commands are available through RS-232 programming. The **SYSTEM:LOCAL**, **SYSTEM:REMOte**, and **SYSTEM:RWLock** commands are only available through the RS-232 interface.

SYSTEM:LOCAL Places the ac source in local mode during RS-232 operation. The front panel keys are functional.

SYSTEM:REMOte Places the ac source in remote mode during RS-232 operation. All front panel keys except the Local key are disabled.

SYSTEM:RWLock Places the ac source in remote mode during RS-232 operation. All front panel keys including the Local key are disabled.

RS-232 Data Format

- ◆ constant 11-bit data format
- ◆ one start bit
- ◆ seven data bits plus a parity bit (even or odd parity), or eight data bits without parity (parity bit is "0")
- ◆ two stop bits

You can specify one of the following baud rates: 300 600 1200 2400 4800 9600

NOTE: The ac source always uses one start bit and two stop bits regardless of the baud rate. The number of start and stop bits is not programmable.

RS-232 Connector

The RS-232 connector is a DB-9, male connector. You can connect the ac source to any computer or terminal with a properly configured DB-25 connector. You can use a standard Agilent 24542G or 24542H interface cable.

Table 2-2. RS-232 Connector

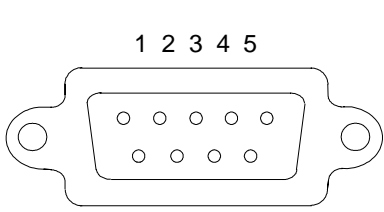
	Pin	Input/Output	Description
	1	Output	Reserved for service use
	2	Input	Receive Data (RxD)
	3	Output	Transmit Data (TxD)
	4	Output	Data Terminal Ready (DTR)
	5	Common	Signal ground
	6	Input	Data Set Ready (DSR)
	7		no connection
	8		no connection
	9	Output	Reserved for service use

2 - Installation

Hardware Handshake

The RS-232 interface uses the DTR (data terminal ready) line as a holdoff signal to the bus controller. When DTR is true, the bus controller may send data to the ac source. When DTR goes false, the bus controller must stop sending data within 10 characters, and must not send any more data until DTR goes true again. The ac source sets DTR false under two conditions.

1. When the input buffer is full (approximately 100 characters have been received), it will set DTR false. When enough characters have been removed to make space in the input buffer, DTR will be set to true, unless condition 2 (see below) prevents this.
2. When the ac source wants to "talk", which means that it has processed a query, and has seen a <newline> message terminator, it will set DTR false. This implies that once a query has been sent to the power source, the bus controller should read the response before attempting to send more data. It also means that a <newline> must terminate the command string. After the response has been output, the ac source will set DTR true again, unless condition #1 prevents this.

The ac source monitors the DSR (data set ready) line to determine when the bus controller is ready to accept data. It checks this line before each character is sent, and the output is suspended if DSR is false. When DSR goes true, transmission will resume. The ac source will leave DTR false while output is suspended. A form of deadlock exists until the bus controller asserts DSR true to allow the ac source to complete the transmission.

Control-C is the equivalent to the GPIB device clear command. It clears the operation in progress and discards any pending output. For the control-C character to be recognized by the power source while it holds DTR false, the bus controller must first set DSR false.

Null modem RS-232 interface cables swap the DTR and DSR lines as shown in the following figure. For other bus controllers or languages, you must determine what form of hardware handshake is used. You may have to build a customized cable to connect the holdoff lines as necessary. If your bus controller does not use hardware handshaking, tie the DSR input to the ac source to a signal that is always true. This implies that your bus controller must always be ready to accept data. You may want to set the baud rate to either 2400 or 4800 baud to ensure that this is true.

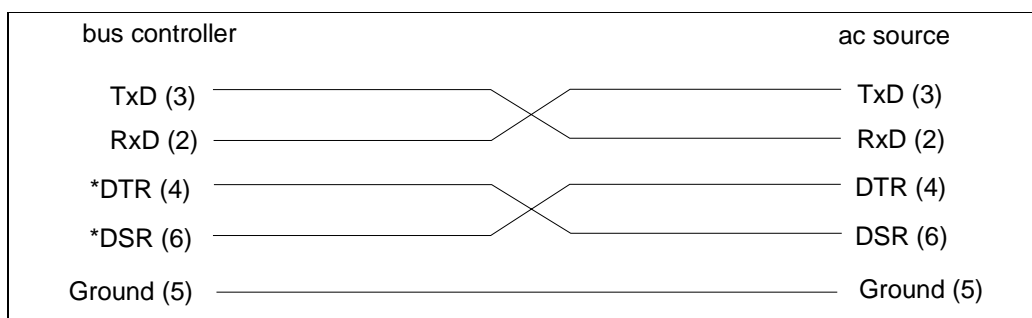

Figure 2-7. Null Modem Interface Lines

Response Data Terminator

All RS-232 response data sent by the ac source is terminated by the ASCII character pair <carriage return><newline>. This differs from GPIB response data which is terminated by the single character <newline>.

Turn-On Checkout

Introduction

Successful tests in this chapter provide a high degree of confidence that the ac source is operating properly. For verification tests, see appendix B. Complete performance tests are given in the Service Guide.

NOTE: This chapter provides a preliminary introduction to the ac source front panel. See Chapter 4 for more details.

Preliminary Checkout









WARNING: *LETHAL VOLTAGES.* Ac sources can supply 425 V peak at their output. **DEATH on contact may result if the output terminals or circuits connected to the output are touched when power is applied.**

1. If you have not already done so, connect the power cord to the ac source and plug it in.
 2. Turn the front panel power switch to ON (1).
 3. The ac source undergoes a self-test when you turn it on. The following items appear on the display:
 - a. A brief pattern that lights all display segments, followed by the model number and the software revision number.
 - b. The display then goes into the meter mode with the **Dis** annunciator on, and all others off. "Meter mode" means that the VOLTS digits indicate the output voltage and the FREQ digits indicate the output frequency. The voltage will be at or near zero and the frequency will be at 60 Hertz.
-

NOTE: If the ac source detects an error during self-test, the **Err** annunciator on the display will be lit. Pressing the **Shift** and **Error** keys will show the error number. Go to "In Case of Trouble" at the end of this chapter.

4. Check that the ac source fan is on. You should be able to hear the fan and feel the air coming from the unit.
5. Press **Output on/off** once. The **Dis** annunciator will go off and the **CV** annunciator will go on. If the programmed voltage is less than 20% of the voltage range, the **Unr** annunciator may go on.
6. Turn the unit off.

Using the Keypad

-  (shift) Some of the front panel keys perform two functions, one labeled in black and the other in blue. You access the blue function by first pressing the blue shift key. Release the key after you press it. The **Shift** annunciator will be on, indicating that you have access to any key's shifted function.
-  And  These keys let you scroll up and down through the choices in the presently selected function menu. All menu lists are circular; you can return to the starting position by continuously pressing either key.
-  and  These keys let you select the previous or the next parameter for a specific command. If the command has a numeric range, these keys increment or decrement the existing value.
-  The backspace key is an erase key. If you make a mistake entering a digit and have not yet pressed **Enter**, you can delete the digit by pressing . Delete more digits by repeatedly pressing this key.
-  Executes the entered value or parameter of the presently accessed command. Until you press this key, the parameters you enter with the other keys are displayed but not entered into the ac source. After pressing **Enter**, the ac source returns to Meter mode in most cases. In Harmonic or List mode, the ac source displays the next point in the list.

Checkout Procedure

WARNING: *LETHAL VOLTAGES.* Ac sources can supply 425 V peak at their output. **DEATH on contact may result if the output terminals or circuits connected to the output are touched when power is applied.**

The output test requires that you connect light bulbs to the output of the unit and apply a potentially hazardous voltage of 120 Vac. Properly shield all connections and wires.

The test in this section checks for output voltage and current on the ac source by having you connect light bulbs to the output of the unit. The following equipment is recommended for performing this output checkout procedure:

- ◆ 1 - 100 W light bulb for Agilent 6814B/6843A; 3 - 100 W light bulbs for Agilent 6834B
- ◆ 1 - light bulb socket for Agilent 6814B/6843A; 3 - sockets for Agilent 6834B
- ◆ wires for connecting socket to the unit

NOTE: When the ac source is turned on as shipped from the factory, it asserts the *RST state. You can subsequently program the unit to turn on according to the state stored in *RCL location 0, as explained in Chapter 4. The following procedures assume that the unit turns on in the *RST state.

Make sure that the unit is turned off, and make the following connections to the output. If you are verifying a single phase source, you only need to connect one bulb.

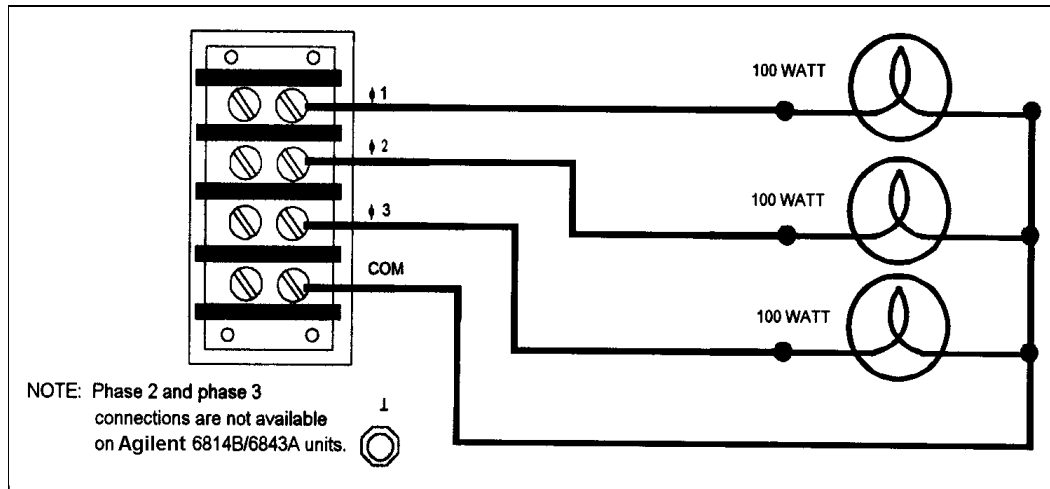

Figure 3-1. Verification Connections

Procedure	Display	Explanation
1. Turn the unit on.	Meter mode	Meter mode is active and the Dis annunciator should be on.
2. Press the Voltage key.	VOLT 0.00	Display indicates the default settings. If you are verifying a three phase source , all phase annunciators should be on.
3. Press Phase Select until only $\phi 1$ is lit.	VOLT 0.00	Single phase units use only phase 1.
4. Press 1, 2, 0, Enter	VOLT 120	Programs the output on phase 1 to 120 Vrms. After the value is entered, the display returns to Meter mode, which indicates that no voltage is applied to the output.
5. Press Output On/Off	120 V 60 Hz	Turns the output on and applies 120 volts to the phase 1 light bulb. The Dis annunciator should be off and CV should be on.

If you are verifying three phase sources, repeat steps 2 through 4 for phase 2 and phase 3. All three light bulbs should be lit when this action is complete.

Continue with step 6 of you are verifying three phase sources. Otherwise skip to step #10.

6. Press the Voltage key.	VOLT 120	
7. Press Phase Select until all phase annunciators are lit	VOLT 120	
8. Press 0, Enter	VOLT 0	Turns off all light bulbs connected to the three-phase source.
9. Press Voltage 1, 2, 0, Enter	VOLT 120	Turns on all light bulbs connected to the three-phase source.
10. Press Protect	PROT: CLEAR	Display accesses the protection menu list.

3 - Turn-On Checkout

	Procedure	Display	Explanation
11.	Press ▲ or ▼ and scroll to the VOLT:PROT item	VOLT:PROT 500	Display shows the overvoltage protection trip voltage for your unit. The overvoltage protection voltage is programmed in peak , not rms volts.
12.	Press 1, 6, 0, Enter	VOLT:PROT 160 0 V 60 Hz	Programs the OVP to 160 V _{peak} , the rms value of which is less than the previously set rms voltage. Because the peak OVP voltage entered was less than the rms output voltage, the OVP circuit tripped. The output dropped to zero, CV turned off, and Prot turned on.
13.	Press Protect , scroll to the VOLT:PROT item, and press 3, 2, 0, Enter	VOLT:PROT 320	Programs the OVP to a peak value that is greater than the rms output voltage value. Note: You cannot clear an OVP trip until you have first removed the cause of the condition.
14.	Press Protect , and Enter	120 V 60 Hz	Executes the PROT:CLEAR command, restoring the output. Prot turns off and CV turns on.
15.	Press Shift , and Current	CURR:LEV 5	Indicates the default output current limit setting.
16.	Press . 5 Enter	CURR:LEV .5	Sets the current limit to .5 amperes. The CC annunciator is on, indicating that the unit is in current limit mode and the light bulbs are dimmer because the output voltage has dropped in its attempt to limit output current.
17.	Press Protect , scroll to the CURR:PROT item, and press ↓ to select ON. Then press Enter .	CURR:PROT ON	You have enabled the overcurrent protection circuit. The circuit then tripped because of the output short. The CC annunciator turns off and the OCP and Prot annunciators come on. The output current is near zero.
18.	Press Output On/Off	0.5 V 60 Hz	The output is off and the Dis annunciator turns on.
19.	Press Protect , scroll to the CURR:PROT item, press ↓ to select OFF, then press Enter .	CURR:PROT OFF	You have disabled the overcurrent protection circuit. The Prot annunciator turns off.
20.	Turn the unit off.		The next time the unit turns on it will be restored to the *RST or factory default state

In Case of Trouble

Error Messages

Ac source failure may occur during power-on selftest or during operation. In either case, the display may show an error message that indicates the reason for the failure.

Selftest Errors

Pressing the **Shift** and **Error** keys will show the error number. Selftest error messages appear as: ERROR <n>, where "n" is a number listed in the following table. If this occurs, turn the power off and then back on to see if the error persists. If the error message persists, the ac source requires service.

Table 3-1. Power-On Selftest Errors

Error No.	Failed Test
Error 0	No error
Error 1	Non-volatile RAM RD0 section checksum failed
Error 2	Non-volatile RAM CONFIG section checksum failed
Error 3	Non-volatile RAM CAL section checksum failed
Error 4	Non-volatile RAM WAVEFORM section checksum failed
Error 5	Non-volatile RAM STATE section checksum failed
Error 6	Non-volatile RAM LIST section checksum failed
Error 10	RAM selftest
Error 11 to 18	DAC selftest 1 to 8

Runtime Error Messages

Under unusual operating conditions, the front panel display may show **OVL**D. This indicates that the output voltage or current is beyond the range of the meter readback circuit. If the front panel display indicates `-- -- -- -- --`, a GPIB measurement is in progress. Appendix C lists other error messages that may appear at runtime.

Line Fuse

If the ac source appears "dead" with a blank display and the fan not running, first check your power source to be certain line voltage is being supplied to the ac source. If the power source is normal, the ac source line fuse may be defective. If the ac source has a defective fuse, replace it only once. If it fails again, investigate the reason for the failure. Proceed as follows:

1. Turn off the front panel power switch and remove the input power (unplug the power cord or open the safety disconnect).
2. Remove the fuse cover from the rear panel.
3. Unscrew the fuse caps and remove the fuses.
4. If any fuses are defective, replace **all three** with fuses of the same type (see Chapter 1).
5. Turn on the ac source and check the operation. If it is normal, replace the fuse cover.

Maintenance Note: It is recommended that new fuses be installed every four years.

Front panel Operation

Introduction

Here is what you will find in this chapter:

- ◆ a complete description of the front panel controls
- ◆ front panel programming examples that describe:
 - how to program the output voltage and frequency
 - how to measure the output
 - how to program the output pulses and lists
 - how to trigger output changes

Front Panel Description

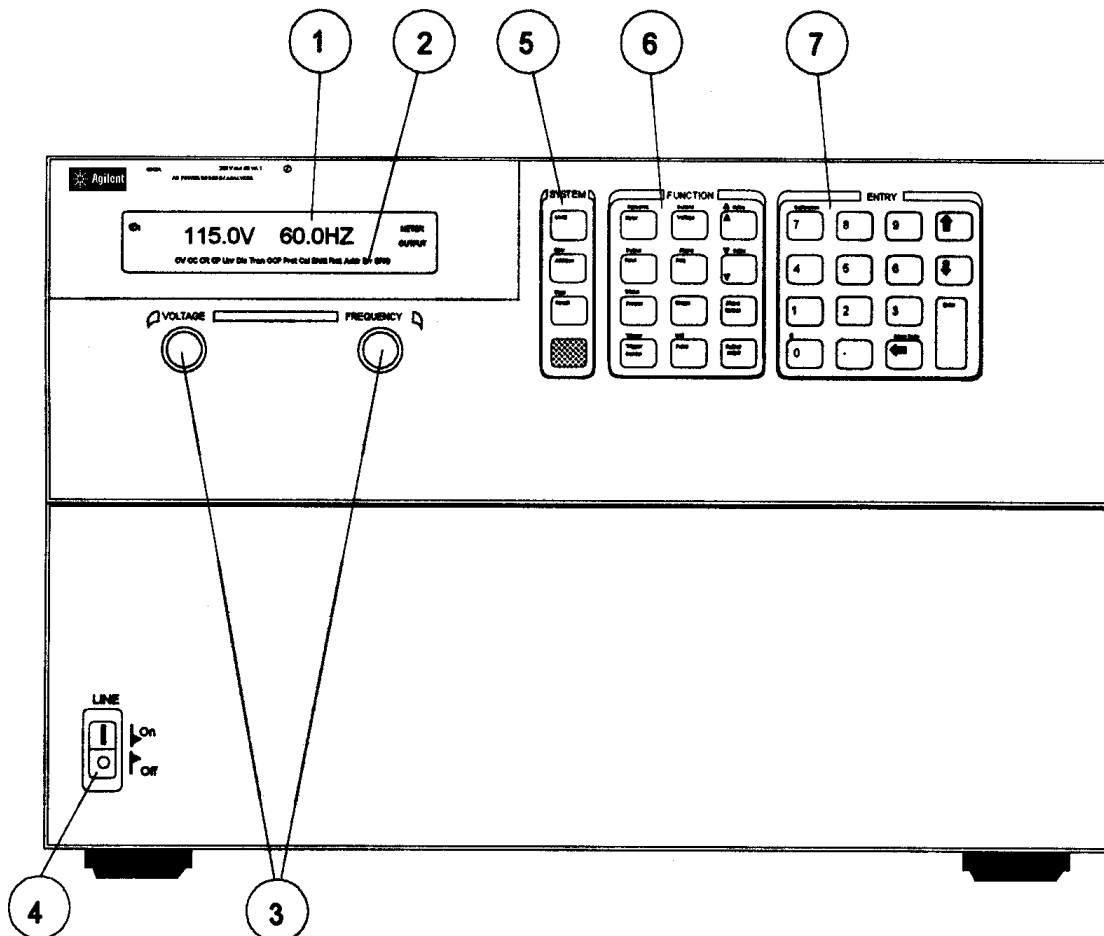

Figure 4-1. Front Panel, Overall View

4 - Front Panel Operation

- ① **Display** 14-character vacuum fluorescent display for showing programmed commands and measured values.
- ② **Annunciators** Annunciators light to indicate operating modes and status conditions:
φ1, φ2, φ3 Phase 1, 2, or 3 is being controlled or metered.
CV The ac source output is in constant-voltage mode.
CC The ac source output is in constant-current mode.
Unr The ac source output is in an unregulated state.
Dis The ac source output is disabled (off).
Tran The ac source output is initialized to output a transient.
OCP The overcurrent protection state is enabled.
Prot One of the ac source's output protection features is activated.
Cal The ac source is in calibration mode.
Shift The Shift key is pressed to access an alternate key function.
Rmt The selected interface (GPIB or RS-232) is in a remote state.
Addr The interface is addressed to talk or to listen.
Err There is a message in the SCPI error queue.
SRQ The interface is requesting service from the controller.
Meter Front panel measurement functions are: ac only, dc only, or ac+dc
AC+DC
Output The ac source output coupling is: ac only, or ac+dc
AC+DC
- ③ **Voltage/
Frequency** The rotary pulse generators let you set the output voltage and frequency when the ac source is in local mode. Their response is rate sensitive.
Turning a control rapidly provides coarse control of the value.
Turning a control slowly provides fine control of the value.
- ⑤ **Line** This turns the ac source on or off.
- ⑥ **System Keys** The system keys let you:
Return to Local mode (front panel control)
Set the ac source GPIB address
Set the RS-232 interface communication baud rate and parity bit
Display SCPI error codes and clear the error queue
Save and recall up to 4 instrument operating configurations
- ⑦ **Function Keys** Function access command menus that let you:
Program output voltage, current limit, frequency, and output waveforms
Turn the output on and off
Select metering functions
Send immediate triggers from the front panel
Program transient output functions
Set and clear protection functions
Select output phases
Select the coupling for output and meter functions
Monitor instrument status
- ⑧ **Entry Keys** Entry keys let you:
Enter programming values
Increment or decrement programming values
Calibrate the ac source

System Keys

Refer to the examples later in this chapter for more details on the use of these keys.

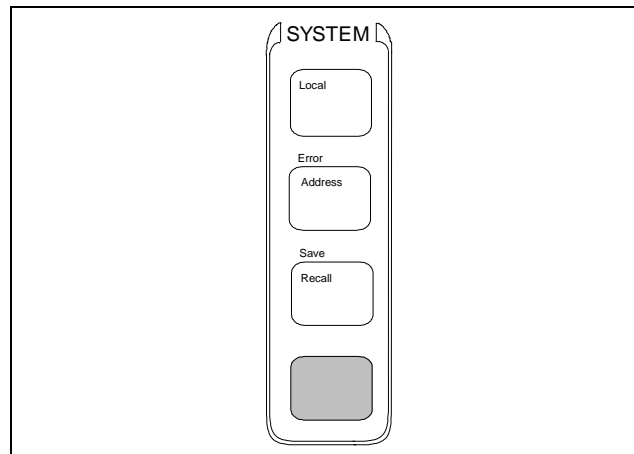



Figure 4-2. System Keys



This is the blue, unlabeled key, which is also shown as  in this guide. Pressing this key accesses the alternate or shifted function of a key (such as **ERROR**). Release the key after you press it. When the **Shift** annunciator is lit, the shifted keys are active.



Press to change the ac source's selected interface from remote operation to local (front panel) operation. Pressing the key will have no effect if the interface state is already Local, Local-with-Lockout, or Remote-with-Lockout.







Press to access the system address menu. This menu lets you configure the ac source's interface and other system parameters. Address Menu entries are stored in non-volatile memory.

Display	Command Function
ADDRESS <value>	Sets the GPIB Address
INTF <char>	Selects an interface (GPIB or RS232)
BAUDRATE<value>	Selects baud rate (300, 600, 1200, 2400, 4800, 9600)
PARITY <char>	Message parity (NONE, EVEN, ODD, MARK, SPACE)
LANG <char>	Selects language (SCPI or E9012)
NOUTPUTS <char>	Select number of output phases on Agilent 6834B only (1 or 3)

value = a numeric value

char = a character string parameter

Use  and  to scroll through the command list.

Use  and  to scroll through the parameter list.



Press to place the ac source into a previously stored state. You can recall up to 16 (0 through 15) previously stored states.



Press to display the system error codes stored in the SCPI error queue. This action also clears the queue. If there is no error in the queue, 0 is displayed.



Press to store an existing ac source state in non-volatile memory. The parameters saved are listed under *SAV in the ac source Programming Guide. You can save up to 16 states (0 through 15).

Function Keys

Refer to the examples later in this chapter for more details on the use of these keys.

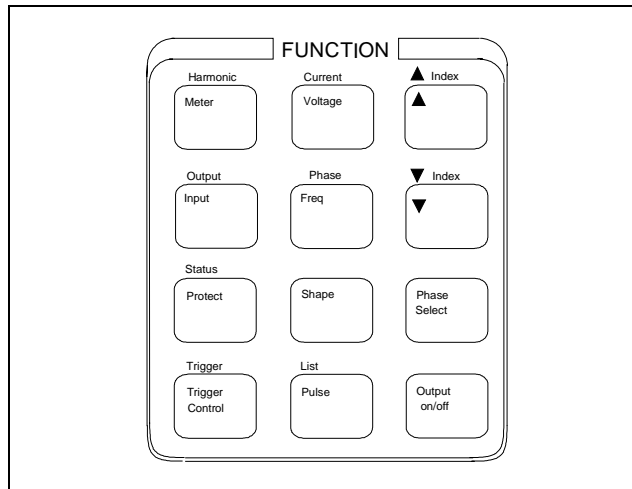

Figure 4-3. Function Keys

Immediate Action Keys

Immediate action keys **immediately** execute their corresponding function when pressed. Other function keys have commands underneath them that are accessed when the key is pressed.

Output
On/Off

This key toggles the output of the ac source between the on and off states. It immediately executes its function as soon as you press it. When off, the ac source output is disabled and the **Dis** annunciator is on.

Phase
Select

This key only applies to three-phase ac sources. It selects the phase to which function commands will be sent, as well as the phase that will be monitored by the Meter and Harmonic functions. At power-on, all phases are selected or coupled, indicating that commands will be sent to all phases. The presently selected phase is indicated by a phase annunciator. Pressing Phase Select immediately selects a different phase. Phase selection is circular; you can return to the starting position by continuously pressing Phase Select.

Annunciator On Phase Selected

$\phi 1, \phi 2, \phi 3$	All phases selected (phases coupled= ALL) ¹
$\phi 1$	Phase #1 selected (phases coupled= NONE)
$\phi 2$	Phase #2 selected (phases coupled= NONE)
$\phi 3$	Phase #3 selected (phases coupled= NONE)

¹ Does not apply to Meter or Harmonic functions.





When the Meter and Harmonic functions are active, Phase Select only rotates through 1, 2, and 3. This is because the Meter and Harmonic functions cannot display multiple phase readings simultaneously. Therefore, it is not possible to select all phases with these functions.





Shift Trigger



Sends an immediate trigger to the ac source

Scrolling Keys

Scrolling keys let you move through the commands in the presently selected function menu.

  These scroll keys let you move through the choices in a command list. Press  to bring up the next command in the list. Press  to go back to the previous command in the list. Function menus are circular; you can return to the starting position by continuously pressing either key. The following example shows the commands in the Input function menu:

    These shifted scroll keys apply only to the Harmonic and List functions. Press these keys to step through integers 0 through 50 when specifying the desired harmonic number, or 0 through 99 when specifying the desired list point. Hold down these keys to rapidly access any harmonic or list point.

  These Entry keys let you scroll through choices in a **parameter** list that apply to a specific command. Parameter lists are circular; you can return to the starting position by continuously pressing either key. If the command has a numeric range, these keys increment or decrement the existing value.

Meter Display Keys

Metering keys control the metering functions of the ac source.

 Press this key to access the meter menu list.

Display

<reading>V <reading>Hz
 <reading>V <reading>A
 <reading>A <reading>Hz
 <reading>V <reading>W
 <reading> CREST F
 <reading>A PK REP
 <reading>A PK NR
 <reading> VA
 <reading> VAR
 <reading>W TOTAL
 <reading> PFACTOR
 <reading>A NEUTRAL

Measurement

rms voltage and frequency (the default)
 rms voltage and rms current
 rms current and frequency (the default)
 rms voltage and power
 current crest factor
 peak current, repetitive
 peak current, nonrepetitive¹
 apparent power
 reactive power
 total power of all phases²
 power factor
 neutral rms current²

 Press this key to specify the following metering functions.

Display

INP:COUP <char>
 WINDOW <char>

Command Function

Choose meter coupling (AC, DC or ACDC)
 Select harmonic measurement window meter (KBESSEL, RECT)

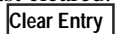

Notes:



¹Displays the highest peak current since it was last cleared. The value is cleared when you scroll into this selection or press  or 

²This selection only valid for Agilent 6834B

reading = the returned measurement

char = a character string parameter

 and  scroll through the command list.

 and  scroll through the parameter list.

4 - Front Panel Operation

Shift **Harmonic** Press this key to access the harmonic menu list

Display	Measurement
<reading>A I:MAG: <index>	current harmonic magnitude
<reading>° I:PHASE: <index>	current harmonic phase
<reading>V V:MAG: <index>	voltage harmonic magnitude
<reading>° V:PHASE: <index>	voltage harmonic phase
<reading>N N:MAG: <index>	neutral current harmonic magnitude
<reading>° N:PHASE: <index>	neutral current harmonic phase
<reading>° CURR:THD	current total % harmonic distortion
<reading>° VOLT:THD	voltage total % harmonic distortion

Output Control Keys

Output control keys control the output functions of the ac source.

Voltage Press this key to access the voltage menu list.

Display	Command Function
VOLT <value>	Set immediate rms output voltage (ϕ)
VOLT:T<value>	Set triggered rms output voltage (ϕ)
VOLT:M <char>	Select the voltage mode (ϕ) (FIXED, STEP, PULSE or LIST)
RANGE <char>	Select the voltage range (ϕ) (150 or 300)
SLEW <value>	Set immediate voltage slew rate in volts/second (ϕ)
SLEW:T<value>	Set triggered voltage slew rate in volts/second (ϕ)
SLEW:M <char>	Select the voltage slew mode (ϕ) (FIXED, STEP, PULSE or LIST)
ALC <char>	Select the voltage sense source (INT or EXT)

Shift **Current** Press this key to access the current menu list.

Display	Command Function
CURR:LEV <value>	Set immediate rms output current limit

Freq Press this key to access the frequency menu list.

Display	Command Function
FREQ <value>	Set immediate output frequency
FREQ:T<value>	Set triggered output frequency
FREQ:M <char>	Select the frequency mode (FIXED, STEP, PULSE or LIST)
SLEW <value>	Set immediate frequency slew rate in volts/second
SLEW:T<value>	Set triggered frequency slew rate in volts/second
SLEW:M <char>	Select the frequency slew mode (FIXED, STEP, PULSE or LIST)

Notes:

ϕ = phase selectable on Agilent 6834B

reading = the returned measurement

index = a numeric value that represents the harmonic number from 0 to 50

char = a character string parameter

▲ and **▼** scroll through the command list.

↑ and **↓** scroll through the parameter list.

▲Index and **▼Index** specify the desired harmonic.

Shift	Phase	Press this key to access the phase menu list.
	Display	Command Function
	PHASE <value>	Set immediate output phase (ϕ)
	PHASE:T <value>	Set triggered output phase (ϕ)
	PHASE:M <char>	Select the phase mode (ϕ) (FIXED, STEP, PULSE or LIST)

Shape	Press this key to access the shape menu list.
	Display
	SHAPE <char>
	SHAPE:T <char>
	SHAPE:M <char>
	CLIP <value>
	Command Function
	Select the immediate output wave shape ¹ (SINE, SQUARE, or CSINE) CSIN = clipped sine wave
	Select the triggered output wave shape (SINE, SQUARE, or CSINE) CSIN = clipped sine wave
	Select the shape mode (FIXED, STEP, PULSE or LIST)
	Set the clipping level of the CSIN wave shape. This specifies the point where clipping starts as a percentage of the peak amplitude or percentage of THD.

Pulse	Press this key to access the pulse menu list.
	Display
	WIDTH <value>
	COUNT <value>
	DCYCLE <value>
	PER <value>
	HOLD <char>
	Command Function
	Set the pulse width
	Set the number of output pulses
	Set the pulse duty cycle as a percentage of the pulse period
	Set the pulse period
	Set the parameter that will be held constant as the other parameters change (WIDTH or DCYCLE)

Shift	Output	Press this key to access the output menu list.
	Display	Command Function
	*RST	Execute *RST command to place the ac source in the factory-default state
	TTLT:SOUR <char>	Select Trigger Out source coupling (BOT, EOT or LIST) BOT = beginning of transient EOT = end of transient LIST = TTLT trigger (see Programming Guide)
	TTLT:STATE <value>	Set Trigger Out state (ON or OFF)
	PON:STATE <char>	Select power-on state command (RST or RCL0)
	RI <char>	Sets remote inhibit mode (LATCHING, LIVE, or OFF)
	DFI <char>	Sets discrete fault indicator state (ON or OFF)
	DFI:SOUR <char>	Select the DFI source (QUES, OPER, ESB, RQS, or OFF) (see Chapter 4 of Programming Guide)



Notes:



¹ User defined waveshapes will also appear in this list when created.

ϕ = phase selectable on Agilent 6834B

value = a numeric value

char = a character string parameter

 and  scroll through the command list.

 and  scroll through the parameter list.

4 - Front Panel Operation

Protection and Status Control Keys

The Protect and Status keys control the protection functions and status registers of the ac source. Refer to Chapter 4 of the Programming guide for more information on the status registers.

Protect

Press this key to access the protection menu list.

Display

PROT: CLEAR

CURR: PROT <char>

VOLT: PROT <value>

DELAY <value>

Command Function

Clear the status registers of all activated protection signals. The fault causing a signal must be corrected or removed before the register can be cleared.

Set overcurrent protection function (ON or OFF).

Set the overvoltage protection level¹

Set the time delay for activating a protection fault after programming the output

Shift

Status

Press this key to access the status menu list. Note that in the following list, commands ending in ? clear the registers when they are read. For this reason the registers are read only after you press **Enter**, not when you scroll to the command

Display

*CLS

STATUS: PRESET

*ESR? <value>

*STB <value>

OPER: EVEN? <value>

OPER: COND <value>

QUES: EVEN? <value>

QUES: COND <value>

Command Function

Executes the clear status (*CLS) command

Execute the STATUS: PRESet command

Return Event Status register value

Return Status Byte register value

Return STAT: OPER: EVENT? value

Return STAT: OPER: COND? value

Return STAT: QUES: EVENT? value



Return STAT: QUES: COND? value



Notes:

¹Programmed in peak volts. (Other voltage parameters are programmed in rms volts)

value = a numeric value

char = a character string parameter

 and  scroll through the command list.

 and  scroll through the parameter list.

Trigger and List Control Keys

The Trigger Control key controls output transient triggers. The List key controls the generation of output lists. A list can contain up to 100 points, each of which can specify an output change (or transient). Refer to Chapter 4 of the Programming Guide for more information about programming triggers and lists.

Trigger Control

Press this key to access the trigger control menu list.

Display

INIT:IMMED
INIT:CONT <char>
TRIG:SOUR <char>

DELAY <value>
ABORT
SYNC:SOUR <char>
SYNC:PHASE <value>

Command Function

Initiate the transient trigger sequence immediately.
Set continuous trigger initiation (ON or OFF).
Select transient trigger source (BUS, EXT, TTLT or IMM).
Set trigger delay in seconds.
Abort all trigger sequences.
Select trigger sync source (PHASE or IMM).
Set synchronous phase reference angle in degrees.

Shift

List

Press this key to access the list commands

Display

COUNT <value>
DWEL:<index> <value>
FREQ:<index> <value>
FSLW:<index> <value>
PHASE:<index> <value>
SHAP:<index> <char>

STEP<char>
TTLT:<index> <value>
VOLT:<index> <value>
VSLW:<index> <value>

Command Function

Specifies the number of times a list repeats.
List of output dwell times.
List of output frequencies.
List of output frequency slew rates
List of output voltage phase angles (ϕ)
List of output waveform shapes.¹
(SINE, SQUARE or CSIN) CSIN = clipped sine wave
Response of list to triggers (ONCE or AUTO).
List of Trigger Out pulses (0=no pulse; 1=pulse).
List of ac output voltages (ϕ)
List of output voltage slew rates (ϕ)

Notes:



¹User-defined waveshapes will also appear in this list when created.



ϕ = phase selectable on Agilent 6834B



value = a numeric value

char = a character string parameter

index = a numeric value that represents a list point from 0 to 99

 and  scroll through the command list.

 and  scroll through the parameter list.

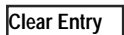
Index and Index scroll through the desired list points. EOL is displayed when the end of the list is reached. When a value is edited, pressing  automatically advances to the next list point. Pressing  truncates or clears the list at the presently displayed list point.

Entry Keys

Refer to the examples later in this chapter for more details on the use of these keys.

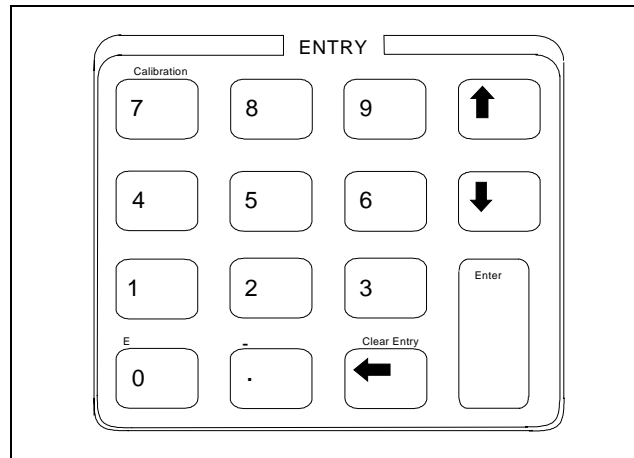
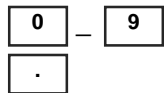

Figure 4-4. Entry Keys



These keys let you scroll through choices in a **parameter** list that apply to a specific command. Parameter lists are circular; you can return to the starting position by continuously pressing either key. If the command has a numeric range, these keys increment or decrement the existing value.



0 through **9** are used for entering numeric values. **.** is the decimal point. For example, to enter 33.6 press: **3 3 . 6 Enter**.



The backspace key deletes the last digit entered from the keypad. This key lets you correct one or more wrong digits before they are entered.



This key executes the entered value or parameter of the presently accessed command. Until you press this key, the parameters you enter with the other Entry keys are displayed but not entered into the ac source. Before pressing **Enter** you can change or abort anything previously entered into the display. After Enter is pressed, the ac source returns to Meter mode in most cases. In Harmonic or List mode, the ac source displays the next point in the list.



This key specifies an exponential power of 10. For example, the value for 100µs can be entered as either **. 0 0 0 1** , or as **1 E - 4**



This key **-** is the minus sign.

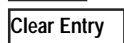

This key aborts a keypad entry by clearing the value. This key is convenient for correcting a wrong value or aborting a value entry. The display then returns to the previously set function. **When editing a list**, pressing **Clear Entry** truncates or clears the list at the presently displayed list point.

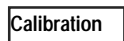

This key accesses the calibration menu (Refer to Appendix B to calibrate your ac source).

Examples of Front Panel Programming

You will find these examples on the following pages:

- 1 Setting the output voltage amplitude
- 2 Setting the output frequency
- 3 Setting the overcurrent protection feature
- 4 Generating step, pulse, and list transients
- 5 Programming trigger delays and phase synchronization
- 6 Programming slew rates
- 7 Measuring peak inrush current
- 8 Setting the GPIB address or RS-232 parameters
- 9 Saving and recalling operating states
- 10 Switching between single- and three- phase operation (Agilent 6834B only)

The examples in the ac source Programming Guide are similar to the ones in this section, except that they use SCPI commands.

1 - Setting the Output Voltage Amplitude

NOTE: The maximum voltage that the ac source can output is limited by the peak value of the waveform, which is $425 V_{\text{peak}}$. Since the output is programmed in units of rms volts, the maximum value that can be programmed is dependent on the peak-to-rms ratio of the selected waveform. For a sinewave, the maximum ac voltage that can be programmed is $300 V_{\text{rms}}$. For other waveforms the maximum may be different.

Procedure for Single-Phase AC Sources

When you turn on the ac source, the default output shape is a 60 Hz sinewave at 0 Vrms. There is no output from the ac source because the default output state is OFF, as indicated by the **Dis** annunciator.

Set the output to 120 V rms as follows:

Action	Display
You can set the voltage in any of three ways:	
1. On the Function keypad, press Voltage . On the Entry keypad, press 1 2 0 Enter . This is the easiest way to enter an accurate value.	VOLT 120
2. On the Function keypad, press Voltage . On the Entry keypad, press ▲ or ▼ to increment or decrement the existing value. This technique is useful when you are making minor changes to an existing value.	VOLT 127
3. Rotate the front panel Voltage knob to obtain 120 V. This method is best when you want to enter a value without using the voltage menu.	120 V 60 Hz
Note: You will not see the new voltage on the front panel meter unless the output is enabled.	
To enable the output:	
4. On the Function keypad, press Output On/Off . The Dis annunciator will go off, indicating that the voltage is now applied to the output terminals.	120 V 60 Hz

4 - Front Panel Operation

Procedure for Three-Phase AC Sources

If you have a three-phase ac source, you can set the rms voltage of all three phases identically, or set each one differently. This is controlled via the Phase Select Menu on the **Function** keypad.

The following example shows how you can set the **phase 1 output to 120 Vrms, phase 2 to 180 Vrms, and phase 3 to 235 Vrms.**

Action	Display
1. On the Function keypad, press Voltage . Note that in the power-on default state, the ϕ 1, ϕ 2, and ϕ 3 annunciators are all lit, indicating that any command sent to the instrument will be sent to all three phases.	VOLT 0
2. Scroll through the phase selections by pressing Phase Select Pressing Phase Select moves you through phases 1, 2, and 3, as indicated by the phase annunciators. Pressing it once more returns you to the first state with all three phase annunciators on.	VOLT 0
3. While in the Voltage menu press Phase Select to access Phase 1. On the Entry pad press 1 2 0 Enter .	VOLT 120
4. Access the Voltage menu again and press Phase Select once to access Phase 2. On the Entry pad press 1 8 0 Enter .	VOLT 180
5. Access the Voltage menu again and press Phase Select once to access Phase 3. On the Entry pad press 2 3 5 Enter .	VOLT 235
6. Press Output On/Off to enable the output. The Dis annunciator will go off, indicating that the voltages are now applied to the output terminals.	235 V 60 Hz
To verify the output, you can measure it as follows:	
7. Note that the ϕ 3 annunciator is on, indicating that you are monitoring the last phase you selected, which was Phase 3.	235 V 60 Hz
8. Press Phase Select once. The ϕ 1 annunciator will light, indicating that you are now monitoring Phase 1.	120 V 60 Hz
9. Press Phase Select once. The ϕ 2 annunciator will light, indicating that you are now monitoring Phase 2.	180 V 60 Hz
10. Press Phase Select once. The ϕ 3 annunciator will light, indicating that you are now monitoring Phase 3 again.	235 V 60 Hz

NOTE: The Meter menu does not go to the all-phases state present in the Phase Select menu because the front panel can display only one phase at a time. Refer to the ac source Programming Guide on how to return simultaneous measurements from all three phases.

2 - Setting the Output Frequency

When you turn on the ac source, the default output frequency is a 60 Hz. Assuming the voltage output from example 1 is in effect (120 Vrms sinewave), **change the frequency to 50 Hz as follows:**

Action	Display
You can set the frequency in the same way that you set the voltage:	
1. On the Function keypad, press Freq. On the Entry keypad, press 5 0 Enter.	FREQ 50
2. On the Function keypad, press Freq. On the Entry keypad, press ▲ or ▼ to increment or decrement the existing value.	FREQ 50
3. Rotate the front panel Frequency knob to obtain 50 Hz.	FREQ 50

To verify the output, you can measure it as follows:

4. On single-phase ac sources, the $\phi 1$ annunciator is lit. On three-phase ac sources, the phase annunciator of the last selected phase will be lit. The Meter menu is presently displaying the measured voltage and frequency of the selected output phase.	120 V 50 Hz
--	-------------

You can scroll through all of the measurement functions in the Meter Menu by pressing the **▲** and **▼** keys.

3 - Setting a Protection Feature

You can set the ac source to disable its output if it detects an overvoltage or overcurrent fault condition. Other automatic fault conditions (such as overtemperature) also will disable the output. **Set the overcurrent protection feature as follows:**

Action	Display
1. On the Function keypad, press Protect.	PROT: CLEAR
2. Press ▼ to obtain the overcurrent command.	CURR: PROT OFF
3. On the Entry keypad, press once to scroll to the ON parameter and press Enter. The OCP annunciator will light, indicating that the overcurrent protection circuit is on. CURR: PROT ON	CURR: PROT ON
If you wish to set a time delay between the detection of the fault and the disabling of the output, scroll to the delay command on the protection menu. The default delay is 100 milliseconds.	DELAY .1
Enter the delay from the Entry keypad, such as . 2 5 0 Enter.	DELAY .250
4. When you want to restore normal operation after the cause of the overcurrent condition has been removed , scroll to the protection clear command and press Enter. The OCP annunciator then will go off.	PROT: CLEAR

4 - Front Panel Operation

4 - Using Transient Voltage Modes

The ac source voltage can be programmed in the following transient operating modes:

STEP	causes the output to permanently change to its triggered value.
PULSE	causes the output to change to its triggered value for a specific time, as determined by the Pulse menu parameters.
LIST	causes the output to sequence through a number of values, as determined by points entered in the List menu.
FIXED	disables transient operation for the selected function.

Step Transient

The Voltage Menu lets you specify an alternate or triggered voltage level that the ac source will apply to the output when it receives a trigger. Because the default transient voltage level is zero volts, you must first enter a triggered voltage before you can trigger the ac source to change the output amplitude. Refer to Chapter 4 of the Programming Guide for more information about programming triggers.

In the following example, **the voltage output is set to 120 Vrms and then stepped down to 102 Vrms.**

Action	Display
1. On the Function keypad, press Output On/Off to enable the output. The Dis annunciator will go off.	0 V 60 Hz
2. Press Voltage to access the Voltage Menu. On the Entry keypad, press 1 2 0 Enter .	VOLT 120
3. Access the Voltage Menu again and press ▼ to access the triggered voltage command.	VOLT:T 0
4. On the Entry keypad, press 1 0 2 Enter .	VOLT:T 102
5. Access the Voltage Menu again and press ▼ to access the voltage mode command. It should be in the default FIXED mode. An ac source function in the FIXED mode does not respond to triggers. On the Entry keypad, press ▲ or ▼ to scroll through the mode parameters. When you have STEP , press Enter .	VOLT:M STEP
6. Press Trigger Control and Enter . This initiates (or enables) one immediate trigger action.	INIT:IMMED
7. Press Shift Trigger . This sends the ac source an immediate trigger signal to change the output voltage. The triggered voltage value now becomes the VOLT value.	102 V 60 HZ

On three-phase ac sources the voltage steps are phase selectable. You can output a different voltage step for each phase. To do this, use **Phase Select** to first choose the desired phase, as previously described in example 1 for setting the immediate output voltage.

Pulse Transient

In the following example, the output is four 83.3-millisecond, 120 Vrms pulses at 60 Hz. The figure shows the trigger, pulse count, pulse period, and duty cycle.

NOTE: From the Output Menu, execute the *RST command to reset the ac source. This is necessary because any previously programmed functions remain in effect until cleared.

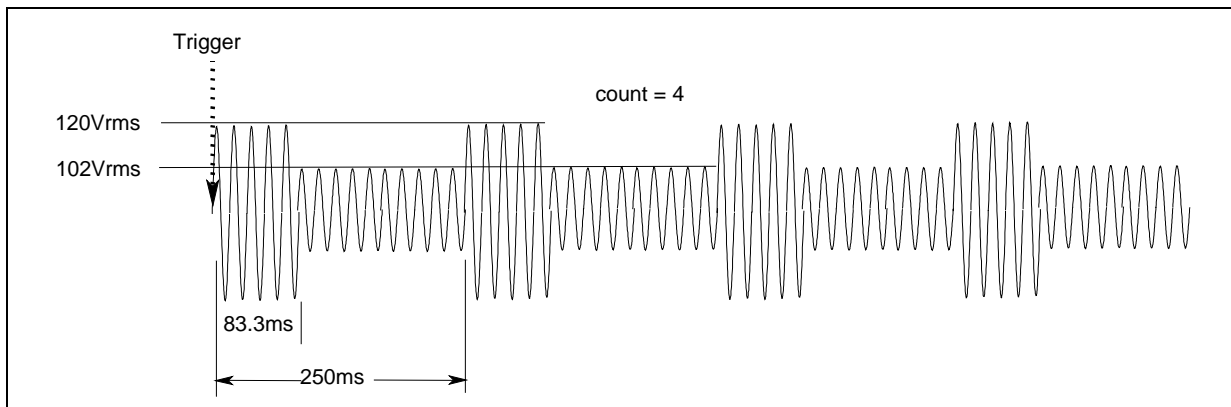

Figure 4-5. Pulse Transients

Action	Display
1. Press Voltage to access the Voltage Menu. On the Entry keypad, press 1 0 2 Enter .	VOLT 102
2. Press ▼ to access the triggered voltage command. On the Entry keypad, press 1 2 0 Enter .	VOLT 120
3. Access the Voltage Menu again and press ▼ to access the voltage mode command. On the Entry keypad, press ▲ or ▼ to scroll through the mode parameters to obtain PULSE and press Enter .	VOLT:M PULSE
4. Press Pulse to access the Pulse Menu. From the Entry keypad, press . 0 8 3 3 Enter to enter a pulse width of 83.3 milliseconds.	WIDTH .0833
5. Access the Pulse Menu and press ▼ to access the duty cycle command. From the Entry keypad, press 3 3 Enter to change the duty cycle to 33%.	DCYCLE 33
6. Access the Pulse Menu and press ▼ to access the pulse count. On the Entry keypad, press 4 and Enter .	COUNT 4
7. Press Trigger Control and Enter to initiate the transient trigger sequence.	INIT:IMMED
8. Press Shift Trigger . This sends the ac source an immediate trigger signal to generate the four output pulses.	102 V 60 HZ

Note: The ac source output returns to 102 V at the completion of the output pulses.

On three-phase ac sources the voltage pulses are phase selectable. You can output a different voltage pulse for each phase. To do this, use **Phase Select** to first choose the desired phase, as previously described in example 1 for setting the immediate output voltage.

4 - Front Panel Operation

List Transient

Lists are the most flexible means of generating multiple or synchronized transient outputs. The following figure shows a voltage output generated from a list. The output shown represents three different ac voltage pulses (160 volts for 33 milliseconds, 120 volts for 83 milliseconds, and 80 volts for 150 milliseconds) separated by 67-millisecond, 0-volt intervals.

The list specifies the pulses as three voltage points (point 0, 2, and 4), each with its corresponding dwell point. The intervals are three zero-voltage points (point 1, 3, and 5) of equal intervals. The count parameter causes the list to execute twice when started by a single trigger.

NOTE: From the Output Menu, execute the *RST command to reset the ac source. This is necessary because any previously programmed functions remain in effect until cleared.

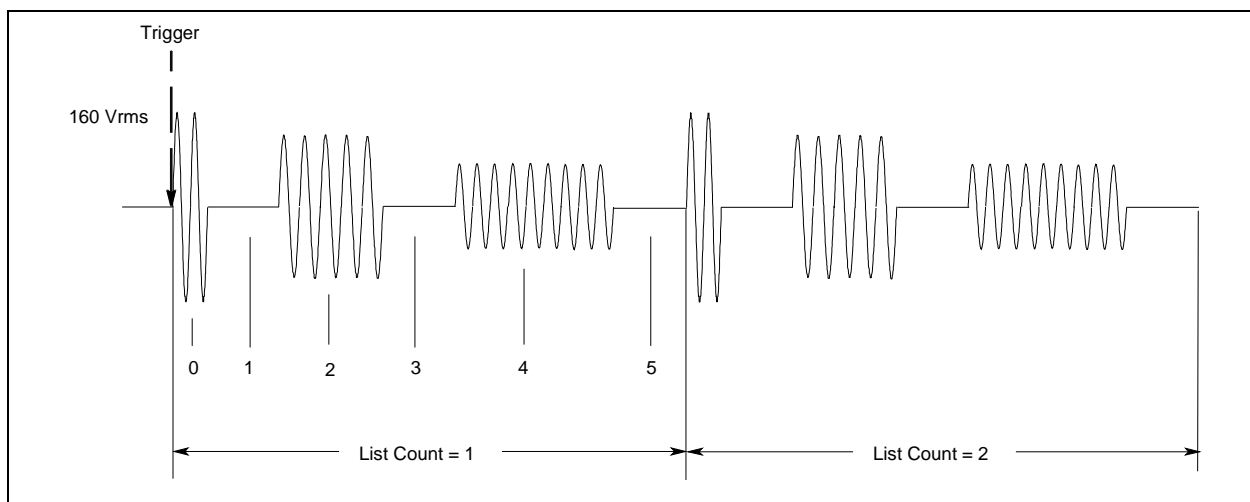

Figure 4-6. List Transients

Action	Display
1. Press Voltage to access the Voltage Menu. Then press ▼ to access the voltage mode command.	VOLT:M FIXED
2. On the Entry keypad, press ▲ or ▼ to scroll through the mode parameters to obtain LIST and press Enter .	VOLT:M LIST
3. Access the List Menu by pressing Shift List . The first menu command is the count. From the Entry keypad, change the list count from the default (1) to 2. Press Enter .	COUNT 2
4. Access the List menu again and press ▼ until you access the dwell time. This specifies the "on" time for each voltage point, which is effectively the output pulse width. The first dwell point (0) appears in the display. On the Entry keypad, press . 0 3 3 and Enter .	DWEL 0 .033
5. Pressing the Enter key automatically advances to the step in the list. Enter the following values for dwell list points 1 through 5: .067, .083, .067, .150, .067. Press Enter to enter each value. When you finish, you will be at point 6, which is the end of the list.	DWEL 1 .067 DWEL 2 .083 DWEL 3 .067 DWEL 4 .150 DWEL 5 .067
Note: Press Shift ▲Index or Shift ▼Index to access and edit any list point.	DWEL 6 EOL

- | | | |
|-----|---|---|
| 6. | Press ▼ until you access the voltage list. This specifies the amplitude of each output point during its corresponding dwell period. The first voltage list point (0) appears in the display. On the Entry keypad, press 1 6 0 and Enter . | VOLT 0 160 |
| 7. | Pressing the Enter key automatically advances to the step in the list. Enter the following values for voltage list points 1 through 5: 0, 120, 0, 80, 0. Press Enter to enter each value. When you finish, you will be at point 6, which is the end of the list.
Note: Press Shift ▲Index or Shift ▼Index to access and edit any list point. | VOLT 1 0
VOLT 2 120
VOLT 3 0
VOLT 4 80
VOLT 5 0
VOLT 6 EOL |
| 8. | Press ▼ until you access the step command. Check that it is at the default mode (AUTO). This lets a single trigger run your list for the specified count. | STEP AUTO |
| 9. | Press Output On/Off to enable the output. The Dis annunciator will go off. | 0 V 60 Hz |
| 10. | Press Trigger Control and Enter to initiate the transient trigger sequence. | INIT:IMMED |
| 11. | Press Shift Trigger . This sends the ac source an immediate trigger to generate the four output pulses. The output returns to the immediate value at the end of the list.
Note: To clear a list, press Clear Entry . This truncates or clears the list at the presently displayed list point. Each list must be accessed and cleared separately. | 0 V 60 Hz |

On three-phase ac sources the voltage lists are phase selectable. You can output a different voltage list for each phase. To do this, use **Phase Select** to first choose the desired phase, as previously described in example 1 for setting the immediate output voltage.

5 - Trigger Delays and Phase Synchronization

The ac source trigger system also lets you program trigger delays as well as synchronize output changes to a specific phase angle of the output waveform.

In example ①, the output transient is triggered immediately at the receipt of the trigger signal. In example ②, a delay time of approximately 16.7 milliseconds elapses between the occurrence of the trigger and the start of the output transient. In example ③, the trigger source is programmed for phase synchronization, which means that the transient occurs at the first occurrence of the specified phase angle after the trigger signal is received. Example ④ describes phase synchronization on three phase ac sources.

Note that phase synchronization is referenced to an internal phase signal. The output of the unit is normally offset by 0° with respect to this internal reference. Because synchronized transient events always occur with respect to the internal reference, the output will normally be in phase with the value programmed for phase synchronization. (The Phase command can be used to change the offset of the output with respect to the internal phase reference.)

4 - Front Panel Operation

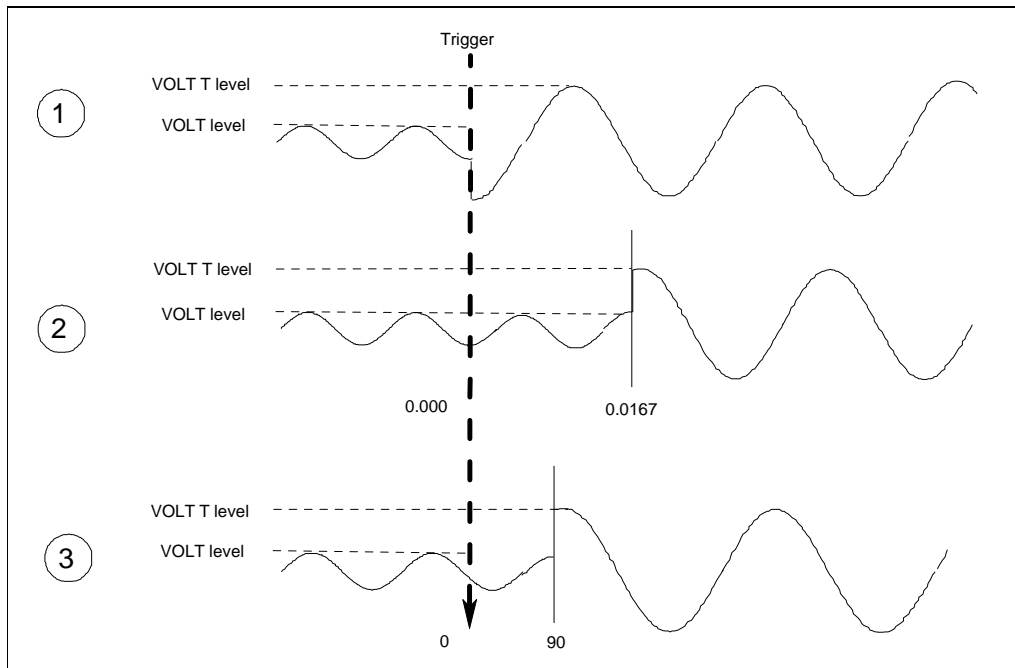

Figure 4-7. Trigger Delays and Phase Synchronization

Example

- ① This example uses the default trigger parameters. First, access the Voltage menu and program the immediate and triggered voltage levels, followed by the voltage transient mode.

Then press **Trigger Control** and **Enter**, followed by **Shift Trigger**.

- ② In this example, you will set a trigger delay. First, access the Voltage menu and program the immediate and triggered voltage levels, followed by the voltage transient mode.

Press **Trigger Control**. Then press **▼** until you access the delay parameter. On the Entry keypad, press **. 0 1 6 7 Enter**.

Then press **Trigger Control** and **Enter**, followed by **Shift Trigger**.

- ③ This example uses the phase sync mode with no delay, but synchronized at 90. First, access the Voltage menu and program the immediate and triggered voltage levels, followed by the voltage transient mode.

Press **Trigger Control**. Press **▼** until you access the delay parameter. If necessary, set it to 0. Press **▼** until you access the sync source command. On the Entry keypad, press **↓** to obtain PHASE. Press **Enter**.

Access the Trigger Control menu again and press **▼** to access the sync phase reference parameter. On the Entry keypad, program a 90° phase reference by entering **9 0 Enter**.

Then press **Trigger Control** and **Enter**, followed by **Shift Trigger**.

Display

```
VOLT 120
VOLT:T 150
VOLT:M STEP
```

```
INIT:IMMED
```

```
VOLT 120
VOLT:T 150
VOLT:M STEP
```

```
DELAY 0
DELAY .0167
```

```
INIT:IMMED
```

```
VOLT 120
VOLT:T 150
VOLT:M STEP
```

```
DELAY 0
SYNC:SOUR PHASE
```

```
SYNC:PHAS 90
```

```
INIT:IMMED
```

On three-phase ac sources, phase 1 is normally offset by 0° from the internal phase reference while phase 2 and phase 3 are offset by 240° and 120° respectively. Therefore, synchronized transient events will occur at the phase angle programmed for the phase 1 output, but at *different* phase angles on the phase 2 and phase 3 outputs.

This is illustrated in the following figure, where the transient occurs at the 90° angle programmed for the phase 1 output, but at 330° and 210° for the phase 2 and 3 outputs, because of the default offsets for these outputs.

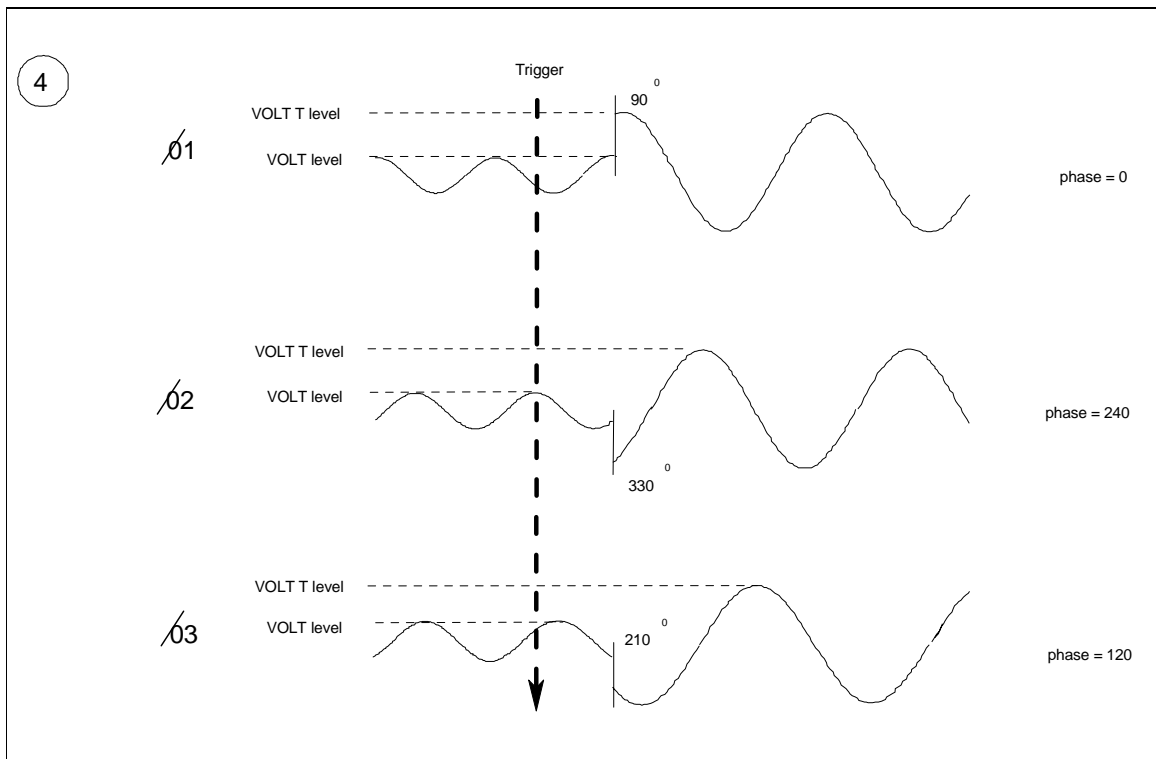

Figure 4-8. Phase Synchronization on Three-phase Sources

Example

④ This example synchronizes a change at 90° on phase 1. First, access the Voltage menu and program the immediate and triggered voltage levels, followed by the voltage transient mode. Check that the $\phi 1$, $\phi 2$, and $\phi 3$ annunciators are all lit, indicating that commands will be sent to all three phases. If not, press **Phase Select** until all three annunciators are lit.

Press **Trigger Control**. Press \blacktriangledown until you access the sync source command. On the Entry keypad, press \blacktriangledown once to obtain PHASE. Press **Enter**.

Access the Trigger Control menu again and press \blacktriangledown to access the sync phase reference parameter. On the Entry keypad, program a 90° phase reference by entering **9 0 Enter**.

Then press **Trigger Control** and **Enter**, followed by **Shift Trigger**.

Display

```
VOLT 120
VOLT:T 150
VOLT:M STEP
```

```
SYNC:SOUR PHASE
```

```
SYNC:PHAS 90
```

```
INIT:IMMED
```

6 - Using Slew Rates to Generate Waveforms

As shown in the previous examples there are a number of ways that you can generate custom waveforms. Programmable slew rates provide additional flexibility when customizing waveforms. The following figure illustrates how programmable slew rates are applied in the transient operating modes.

In example ①, an immediate slew rate of 50 volts/second is used whenever a new output voltage is programmed. In example ②, a triggered slew rate of 50 volts/second steps the voltage level to its new value. 50 volts/second becomes the new immediate slew rate in step mode. In example ③, a triggered slew rate of 50 volts/second is used at the start of the pulse. The immediate slew rate of infinity applies at the trailing edge of the pulse. In example ④, the slew rates are set by the values in the voltage slew list.

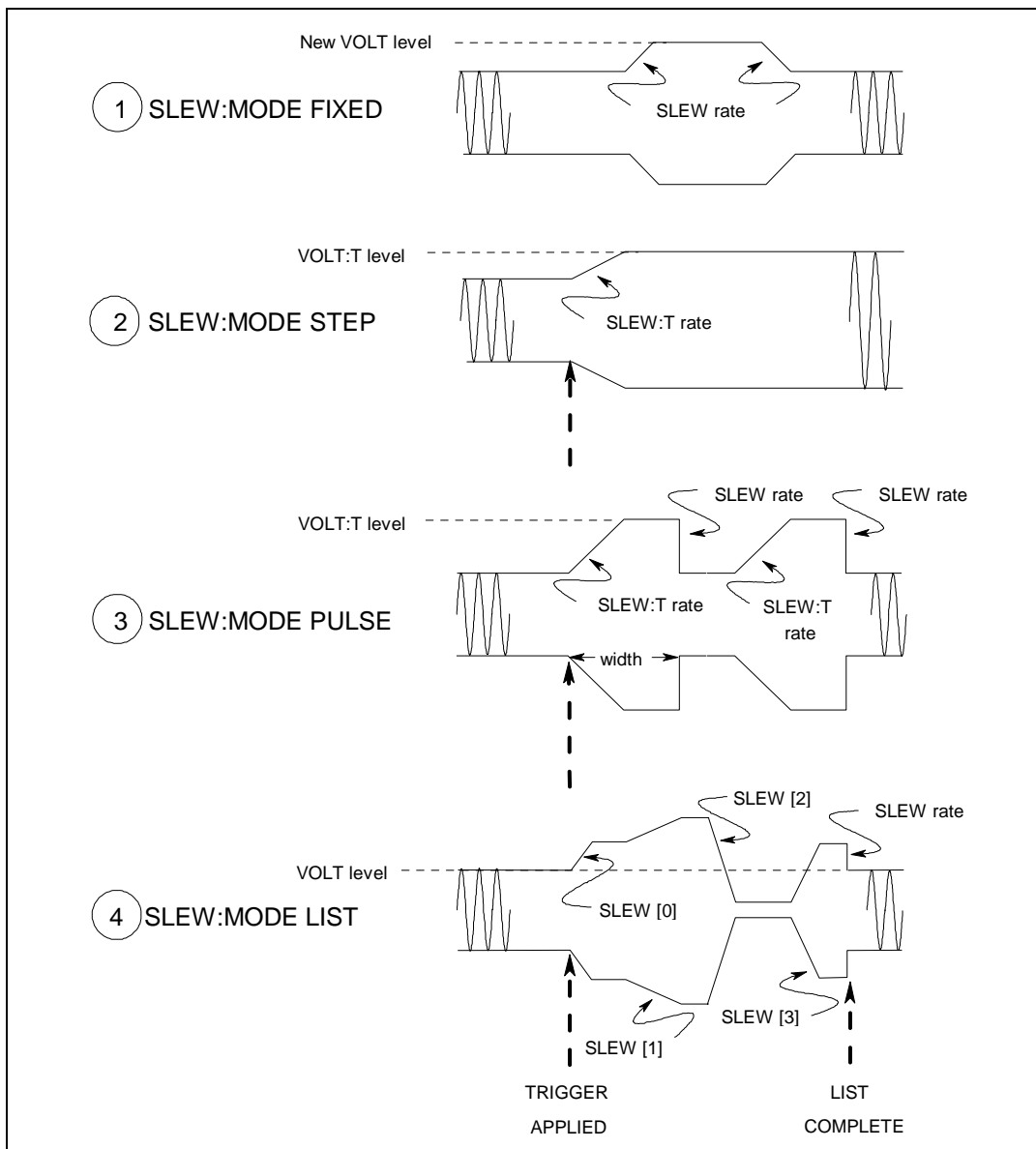

Figure 4-8. Programming Slew Rates

Example

- ① This example uses the immediate slew rate. First, access the Voltage menu and press ▼ until you access the mode command. On the Entry keypad, press ↓ to obtain FIXED. Press **Enter**.

Access the voltage menu and press ▼ until you access the slew command. On the Entry keypad, press **5 0 Enter** to program a slew rate of 50 volts/second.

Whenever a new immediate voltage value is entered, the output will slew to the new level at 50 volts/second.

- ② Step mode uses the triggered slew rate. First, access the Voltage menu, program the immediate and triggered voltage levels, and set the slew mode to STEP.

Access the Voltage menu and press ▼ to access the immediate slew command. On the Entry keypad, enter a value that equals infinity.

Access the Voltage menu and press ▼ until you access the triggered slew command. On the Entry keypad, enter a value such as **5 0 Enter**, which sets the triggered slew rate to 50 volts/second.

Then press **Trigger Control** and **Enter**, followed by **Shift Trigger**.

After the trigger has been sent, in step mode, the triggered value becomes the new immediate value.

- ③ Pulse mode uses the triggered slew rate at the leading edge of the pulse, and the immediate slew rate at the trailing edge of the pulse. First, access the Voltage menu, program the immediate and triggered voltage levels, and set the slew mode to PULSE.

Access the Pulse menu and program the pulse count, duty cycle, and pulse period.

Access the Voltage menu and press ▼ to access the immediate slew command. On the Entry keypad, enter a value that equals infinity.

Access the Voltage menu and press ▼ until you access the triggered slew command. On the Entry keypad, enter a value such as **5 0 Enter**, which sets the triggered slew rate to 50 volts/second.

Then press **Trigger Control** and **Enter**, followed by **Shift Trigger**.

- ④ When the voltage slew mode is set to LIST, the slew rates are set by the values in the voltage slew list. Refer to the List Transient example for more information on how to program lists. You must program the voltage values and dwell times as explained in that example. You must also program a slew rate for each point in the list (even if it is 9.9+E37).

Display

VOLT:M FIXED

SLEW 50

VOLT 120
VOLT:T 150
SLEW:M STEP

SLEW: 9.9+E37

SLEW:T 50

INIT:IMMED

VOLT 120
VOLT:T 150
SLEW:M PULSE

COUNT 2
DCYCLE 33
PER .0166

SLEW: 9.9+E37

SLEW:T 50

INIT:IMMED

NOTE: When specifying a dwell time, you must take the slew time into consideration. If the dwell time at any given list point is less than the slew time at the same point, the voltage will never reach its programmed level before the next list point becomes active.

4 - Front Panel Operation

7 - Measuring Peak Inrush Current

Peak inrush current is a non-repetitive measurement in the sense that peak inrush current occurs only when the unit under test is first turned on. In order to repeat the measurement, you must turn the unit off and wait for any input filter capacitors to discharge completely.

This example shows you how you can measure the peak inrush current using the front panel meter. The voltage is set to 120 V rms and the output is triggered at an output phase of 75°, which optimizes the conditions under which inrush current is applied to the unit under test.

Action	Display
1. Set the immediate voltage to 0. Press Voltage , then press 0 and Enter .	VOLT 0
2. Set the triggered voltage to 120 V rms. In the Voltage menu, press ▼ to access the triggered voltage command. Then press 1 2 0 Enter .	VOLT:T 120
3. Set the voltage mode to step. In the Voltage menu, press ▼ to access the mode command. Press ⏴ to scroll to STEP and press Enter .	VOLT:M STEP
4. Make sure the unit is operating in the low voltage range. (The low voltage range has twice the output current rating of the high voltage range.) In the Voltage menu, press ▼ to access the range command. If necessary, press ⏴ to set the range to 150 and press Enter .	RANGE 150
5. Make sure the triggered voltage slew rate is set to the fastest possible speed. In the Voltage menu, access the triggered slew command. If necessary, reset the slew rate to a faster speed.	SLEW:T 9.9000+E37
6. Make sure the peak current and rms current limits are set to high values. In the Current menu, access the rms current limit and then the peak current limit commands. If necessary, reset the rms current and the peak current limits to higher values. (Agilent 6811B units have an rms current limit of 3.25 A. Agilent 6813B units have an rms current limit of 13 A and a peak current limit of 80 A)	CURR:LEV 6.5 CURR:PEAK 40
7. Synchronize the trigger source with a reference phase angle. In the Trigger Control menu, press ▼ to access the sync source command. Press ⏴ to obtain PHASE and press Enter .	SYNC:SOUR PHASE
8. Set the reference phase angle to 75°. In the Trigger Control menu, press ▼ to access the sync phase command. Then press 7 5 Enter .	SYNC:PHAS 75
9. Initiate (or enable) the unit for one immediate trigger from the front panel. Press Trigger Control and Enter .	INIT:IMMED
10. Set the meter function to measure nonrepetitive peak inrush current. In the Meter menu, press ▼ to access the peak inrush current display.	0 A PK NR
11. Enable the output by pressing Output On/Off.	0 V 60 HZ
12. Send the trigger to step the output from 0 V to 120 V. Press Shift Trigger . The inrush current is displayed on the Meter.	48 A PK NR

On three-phase ac sources you can only return the peak inrush current from the selected phase because the front panel can only display one phase at a time. Refer to the ac source Programming Guide on how to return simultaneous measurements from all three phases.

8 - Setting the GPIB Address and RS-232 Parameters

Your ac source is shipped with the GPIB address set to 5 This address can only be changed from the front panel using the Address menu located under the **Address** key. This menu is also used to select the RS-232 interface and specify RS-232 parameters such baud rate and parity.

Action	Display
To set the GPIB address, proceed as follows:	
1. On the System keypad, press Address .	ADDRESS 5
2. Enter the new address. For example, Press 7, Enter .	ADDRESS 7
To configure the RS-232 interface, proceed as follows:	
1. On the System keypad, press Address .	ADDRESS 5
2. Scroll through the Address menu by pressing ▼ . The interface command lets you select the RS-232 interface. The baudrate command lets you select the baudrate. The parity command lets you select the parity.	INTF RS232 BAUDRATE 600 PARITY EVEN
3. The ▲ and ▼ keys let you select the command parameters.	

9 - Saving and Recalling Operating States

You can save up to 16 states (from location 0 to location 15) in non-volatile memory and recall them from the front panel. All programmable settings are saved. List data, however, cannot be saved in state storage. Only **one** list is saved in non-volatile memory.

Action	Display
To save an operating state in location 1, proceed as follows:	
1. Set the instrument to the operating state that you want to save.	
2. Save this state to location 1. Press Shift Save 1 Enter .	*SAV 1
To recall a saved state in location 1, proceed as follows:	
1. Recall the state saved in location 1 by pressing Recall 1 Enter	*RCL 1
To select the power-on state of the ac source, proceed as follows:	
1. On the Function keypad, press Shift Output , and scroll through the Output menu until you get to the PON state command.	PON:STATE RST
2. Use the ▲ and ▼ keys to select either RST or RCL0. RST sets the power-on state of the unit as defined by the *RST command. RCL0 sets the power-on state of the unit to the state saved in *RCL location 0.	
To clear the non-volatile memory of the ac source, proceed as follows:	
1. On the Function keypad, press Shift Output and scroll to the *RST command. Then press Enter . This returns the unit to the factory-default settings.	*RST
2. Save these settings to location 1. Press Shift Save 1 Enter .	*SAV 1
3. Repeat step #2 for memory locations 2 through 16..	*SAV 2 *SAV 3 *SAV 4*SAV 16

4 - Front Panel Operation

10 - Switching Between Single- and Three-phase Operation (Agilent 6834B only)

When shipped from the factory, the Agilent 6834B ac source is configured for three-phase operation. You can configure the Agilent 6834B for single-phase operation. This increases the available output power for phase 1 from 1.5 kVA to 4.5 kVA.

NOTE: When you configure the Agilent 6834B for single-phase operation, the phase 2 and phase 3 output terminals are internally connected to the phase 1 output terminal. This distributes the increased available output power across the three output terminals.

Additionally, switching the Agilent 6834B between single-phase and three-phase operation causes the following actions:

- ◆ it disables all outputs
- ◆ it reconfigures the current readback and programming calibration constants
- ◆ it returns all lists and *RCL states to their factory default states
- ◆ it reboots the unit, after which the newly selected number of phases becomes available

NOTE: This may require you to reprogram the lists and recall states each time the outputs are switched.

	Action	Display
1.	On the System keypad, press Address .	ADDRESS 5
2.	Press ▼ to scroll through the address menu until you get to the NOUTPUTS command.	NOUTPUTS 3
3.	Use the ▲ and ▼ keys to select the number of output phases; either 1 (single-phase) or 3 (three-phase).	NOUTPUTS 3 NOUTPUTS 1

Specifications

Specifications

Performance specifications are warranted over the ambient temperature range of 0 to 40 °C. Unless otherwise noted, specifications are per phase for a sinewave with a resistive load at an output frequency range of 45 Hz to 5 kHz (45 Hz-1 kHz, Agilent 6843A) after a 30-minute warmup.

Table A-1. Performance Specifications¹

Parameter	Agilent 6814B	Agilent 6834B		Agilent 6843A
Phases:	1	3	1	1
Maximum Output Ratings				
rms Voltage²:	150 V low range; 300 V high range			
Power:	3 kVA	1.5 kVA/phase	4.5 kVA	4.8 kVA
rms Current:	20 A low range 10 A high range	10 A low range 5 A high range	30 A low range 15 A high range	32 A low range 16 A high range
Repetitive peak Current:	80 A low range 40 A high range	40 A low range 20 A high range	120 A low range 60 A high range	96 A low range 48 A high range
Crest Factor (current):	4	4	4	3
Output Frequency Range:	45 Hz–5 kHz			45 Hz–1 kHz
Constant Voltage Ripple and Noise	–60 dB (20 kHz–10 MHz)			
Load Regulation:	0.5%			
Line Regulation:	0.1%			
Maximum Total Harmonic Distortion:	1% (45 Hz–1 kHz); 1% + 1%/kHz (>1 kHz–5 kHz)			
Programming Accuracy (@ 25°C ±5°C)				
rms Voltage:	0.15% + 0.3 V (45–100 Hz) 0.5% + 0.3 V (>100–500 Hz) 1% + 0.3 V (>500–5 kHz)			
Frequency:	0.01% + 10 µHz			
Phase: (Agilent 6834B in 3-phase mode)	N/A	0.1° (45-100 Hz) 1° (>100–1 kHz) 1° + 1%/kHz (>1k–5 kHz)	N/A	N/A
Measurement Accuracy (@25°C ±5°C)				
rms Voltage	0.05% + 250 mV (45 Hz – 1 kHz) 0.05% + 0.1%/kHz + 250 mV (>1 kHz – 5 kHz)			0.05% + 250 mV
rms Current	0.1% + 50 mA	0.1% + 25 mA	0.1% + 50 mA	0.1% + 50 mA
Frequency:	0.01% + 0.01Hz	0.01% + 0.01Hz	0.01% + 0.01Hz	0.01% + 0.01Hz
Power (VA):	0.15% + 5 VA	0.15% + 3 VA	0.15% + 5 VA	0.15% + 9 VA
Power (Watts):	0.15% + 5 W	0.15% + 3 W	0.15% + 5 W	0.15% + 9 W
Power Factor:	0.01	0.01	0.01	0.01

¹Specifications subject to change without notice.

²From line to neutral on Agilent 6834B

Supplemental Characteristics

Table A-2 lists the supplemental characteristics, which are not warranted but are descriptions of typical performance determined either by design or type testing.

Table A-2. Supplemental Characteristics

Parameter	Agilent 6814B	Agilent 6834B	Agilent 6843A
AC Input Voltage Range:	180–235 Vac (3-phase) or 360–440 Vac (3-phase)		
AC Input Frequency:	47–63 Hz		
Output Isolation Voltage:	300 Vrms		
Maximum Input Current (rms):	18 A low range 10 A high range	24 A low range 15 A high range	24 A low range 15 A high range
Maximum Input Power:	5.8 kVA/4.1 kW	8.9 kVA/5.9 kW	8.9 kVA/5.9 kW
Average Programming Accuracy:	0.2% + 80 mA	0.2%+40mA (3-phase) 0.2%+80mA (1-phase)	0.2% + 80 mA
Average Programming Resolution			
rms Voltage:	80 mV	80 mV	80 mV
Overvoltage Programming (OVP):	2 V	2 V	2 V
rms Current:	5 mA	2.5 mA (3-phase) 7.5 mA (1-phase)	7.5 mA
Output Frequency:	10 µHz	10 µHz	10 µHz
Phase (Agilent 6834B in 3-phase mode):	N/A	0.001° (45Hz–1kHz)	N/A
Average Measurement Resolution			
rms Voltage:	10 mV	10 mV	10 mV
rmsCurrent:	3 mA	6 mA (3-phase) 2 mA (1-phase)	6 mA
List Dwell Time	0–4.30133 x 10 ⁵ s	0–1.07533 x 10 ⁶ s	0–4.30133 x 10 ⁵ s
Triggering Accuracy with Respect to Phase Synchronization:	100 µs	250 µs	100 µs
Trigger In Response Time:	200 µs	400 µs	200 µs
Minimum Resolution for Dropout:	500 µs		
Output Response Time: (output change from 10 to 90% or 90 to 10% of its total excursion with full resistive load)	50 µs		
Remote Inhibit Response Time:	<1 ms		
Remote Sense Capability:	Up to 10 Vrms can be dropped across each load lead.		
Waveform Table Resolution (voltage):	1024 points		
Harmonic Measurement Time (amplitude):	1 harmonic ≤100 ms; all 50 harmonics ≤2 s		
RS-232 Interface Capabilities			
Baud Rates:	300, 600, 1200, 2400, 4800, 9600		
Data Format:	7 bits even or odd parity; 8 bits without parity		
Language:	SCPI (Standard Commands for Programmable Instruments), Elgar 9012 PIP		
Trig In/Trig Out Characteristics			
Trig Out (HC TTL output):	V _{o1} = 0.8 max. @ 1.25 mA V _{oh} = 3.3 V max. @ 1.25 mA		
Trig In (10k pullup):	V _{il} = 0.8 V max. V _{ih} = 2 V max.		

Table A-2. Supplemental Characteristics (continued)

Parameter	Agilent 6814B	Agilent 6834B	Agilent 6843A
INH/FLT Characteristics Maximum Ratings: INH Terminals: FLT Terminals:	16.5 Vdc between INH terminals; FLT terminals; and from INH terminals to chassis ground $I_{ol} = 1.25 \text{ mA max.}$ $V_{ol} = 0.5 \text{ Vmax.}$ $V_{il} = 0.8 \text{ V max.}$ $V_{ih} = 2 \text{ V min.}$ $tw = 100 \text{ } \mu\text{s min.}$ $td = 4 \text{ ms typical}$		
Saveable Data (nonvolatile) Instrument States: User-defined waveforms: List Data:	16 (0 to 15) 12 (with 1024 data points in each) 1 to 100 points (for each list function)		
GPIB Interface Capabilities Language: Interface: Programming Time:	SCPI, Elgar 9012 PIP AH1, C0, DC1, DT1, E2, LE1, PP0, RL1, SH1, SR1, TE6 10 ms		
Recommended Calibration Interval:	1 year		
Regulatory Compliance Listed to: Certified to: Conforms to:	UL 3111-1 CSA 22.2 No. 1010-1 IEC 1010		
RFI Suppression Complies with:	CISPR-11, Group 1, Class A		
Dimensions Height (add 12.7 mm or 0.5 in. for feet) Width: Depth:	262.6 mm (10.3 in.) 430.8 mm (16.96 in.) 602 mm (23.7 in.)		
Net Weight:	79.5 kg (175 lb)	87.7 kg (193 lb)	87.7 kg (193 lb)
Shipping Weight:	119.1 kg (626 lb)	127.3 kg (280 lb)	127.3 kg (280 lb)

Verification and Calibration

Introduction

This appendix includes verification and calibration procedures for the Agilent 6814B/6834B/6843A AC Power Solutions. Instructions are given for performing the procedures either from the front panel or from a controller over the GPIB.

The verification procedures do not check all the operating parameters, but verify that the ac source is performing properly. Performance Tests, which check all the specifications of the ac source, are given in the applicable ac source Service Manual.

Because the output of the ac source must be enabled during verification or calibration, proceed with caution, since voltages and currents will be active at the output terminals.

Important Perform the verification procedures before calibrating your ac source. If the ac source passes the verification procedures, the unit is operating within its calibration limits and does not need to be recalibrated.

WARNING *LETHAL VOLTAGES.* Ac sources can supply 424 V peak at their output. DEATH on contact may result if the output terminals or circuits connected to the output are touched when power is applied. These procedures must be performed by a qualified electronics technician or engineer trained on this equipment.

Equipment Required

The equipment listed in the following table, or the equivalent to this equipment, is required for verification and calibration.

Table B-1. Equipment Required

Equipment	Characteristics	Recommended Model
Digital Voltmeter	Resolution: 10 nV @ 1 V Readout: 8.5 digits Accuracy: >20 ppm	Agilent 3458A
Current Monitor ¹	0.01 Ω, ±200 ppm, (Agilent 6814B/6834B) 0.001 Ω, ±200 ppm, (Agilent 6843A)	Guildline 7320/0.01 Norma Gerts Instruments
Ratio Transformer ²	30:1 ratio, 50 ppm, 45 Hz to 1 kHz	
Load Resistors	2 – 15 Ω, > 1.5 kW (Agilent 6814B/6834B) 1 – 5 Ω, > 4.8 kW non-inductive (Agilent 6843A)	
Impedance Resistor	1 Ω, 100 Watts min. (Agilent 6843A only)	
GPIB Controller	Full GPIB capabilities	HP Series 200/300 or equivalent

¹The 4-terminal current shunt is used to eliminate output current measurement error caused by voltage drops in the load leads and connections. Connect the voltmeter directly to these current-monitoring terminals.

²A ratio transformer is required only when verifying output voltage readback to MIL-STD-45662A 4:1 test equipment ratio requirements.

B - Verification and Calibration

Test Setup

Figure B-1 shows the setup for the tests. Be certain to use load leads of sufficient wire gauge to carry the full output current (see Chapter 2).

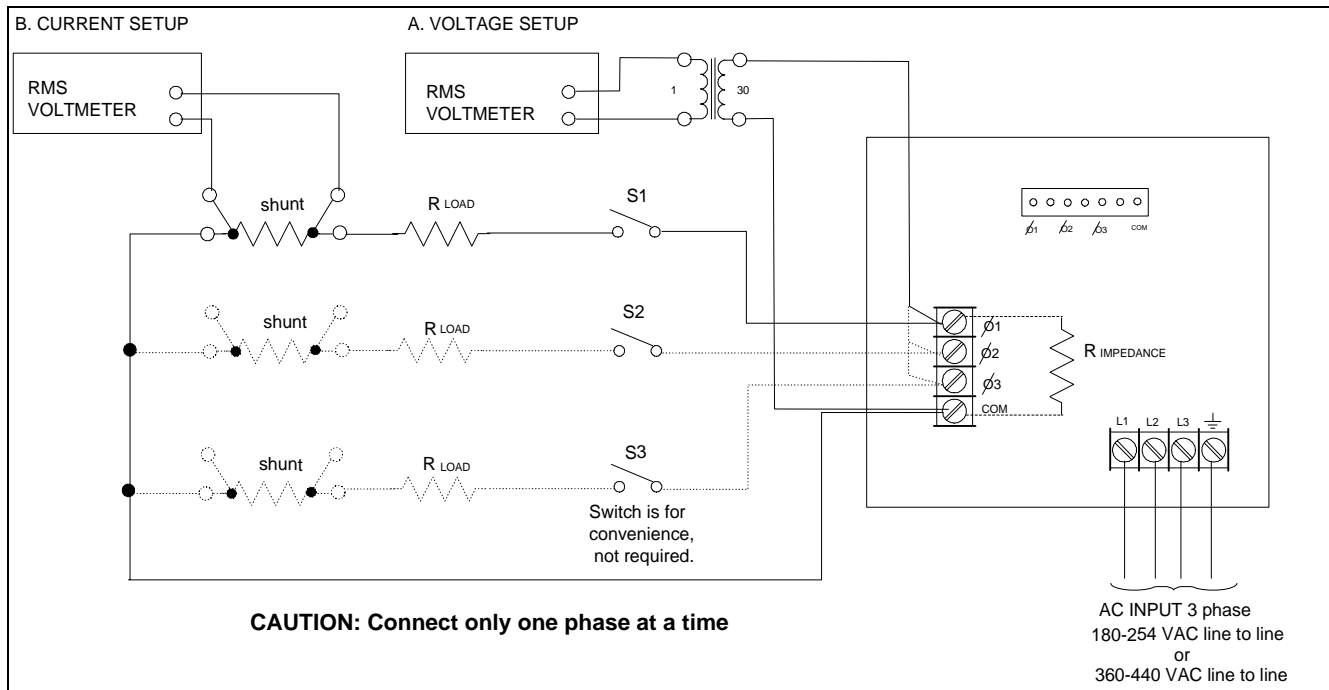

Figure B-1. Verification & Calibration Test Setup

Performing the Verification Tests

The following procedures assume you understand how to operate the ac source from the front panel as explained in Chapter 4.

When performing the verification tests from a GPIB controller, you may have to consider the relatively slow settling times and slew rates of the ac source as compared to computer and system voltmeters. Insert suitable WAIT statements into the test program to give the ac source time to respond to test commands.

Perform the following tests for operation verification in the order indicated.

1. Turn-On Checkout
2. Voltage Programming and Measurement Accuracy
3. Current Measurement Accuracy

Turn-On Checkout Procedure

Perform the Turn-On Checkout as directed in Chapter 3.

NOTE: The ac source must pass turn-on selftest before you can proceed with the verification tests.

Voltage Programming and Measurement Accuracy

This test verifies the voltage programming, GPIB measurement, and front panel meter functions. Values read back over the GPIB should be the same as those displayed on the front panel.

Figure B-1 shows the setup. Measure the ac output voltage directly at the output terminals. **If you are verifying a three-phase source**, start by verifying output phase 1.

Action	Normal Result
1. Make sure the ac source is turned off. Connect the DVM and ratio transformer as shown in the test setup in Figure B-1.	
2. Turn on the ac source with no load. In the Output menu, execute the *RST command to reset the unit to its factory default state.	*RST
3. Program the output voltage to 150 volts and set the output current limit to its maximum value.	CV annunciator on. Output voltage near 0. Output current near 0.
4. Enable the output by pressing Output On/Off .	Output voltage near 150 V.
5. Record voltage readings at the DVM ¹ and on the front panel display.	Readings within low voltage limits specified in table B-2.
6. Program the output voltage to 300 volts.	Output voltage near 300 V.
7. Record voltage readings at the DVM ¹ and on the front panel display.	Readings within high voltage limits specified in table B-2.
8. If you are verifying a 3-phase source , repeat steps 1 through 7 for phases 2 and 3. Press Phase Select to select the next phase.	Readings within specified High range limits (300 V/1 kHz).

¹Multiply the DVM reading by the transformer ratio if a ratio transformer is used.

RMS Current Readback Accuracy

This test verifies the current readback. Use the appropriate current shunt with the accuracy specified in table B-1. Use wire of sufficient size to carry the maximum rated current of the ac source (see table 2-1).

If you are verifying a 3-phase source, start by verifying phase 1.

Action	Normal Result
1. Turn off the ac source. Connect the load resistor, current shunt, and the DVM across the current shunt as shown in Figure B-1. Use the following load resistor values: Agilent 6814B = 7.5Ω; Agilent 6834B = 15Ω; Agilent 6843A = 5Ω	
2. Turn on the ac source. In the Output menu, execute the *RST command to reset the unit to its factory default state.	*RST
3. Program the output voltage to 100 volts and set the current limit as follows: Agilent 6814B = 10 A; Agilent 6834B = 5A; Agilent 6843A = 15A Then enable the output by pressing Output On/Off .	CC annunciator on. Output current near 10 A for Agilent 6814B near 5 A for Agilent 6834B near 15A for Agilent 6843A
4. Record the DVM voltage reading and calculate the rms current. Divide the DVM reading by the current monitor resistor value. Record the front panel reading.	Difference between the measured output current and front panel readings are within specified limits.
5. If you are verifying a 3-phase source , repeat steps 1 through 4 for phases 2 and 3. Press Phase Select to select the next phase.	

B - Verification and Calibration

Table B-2. Agilent 6814B/6834B/6843A Verification Test Record

Model _____		Report No. _____		Date _____	
Test Description	Minimum Specification	Recorded Results	Maximum Specification		
Voltage Programming and Measurement Accuracy					
Low voltage (150 Vrms) Front Panel Measurement	149.5 V Vout -300 mV	_____ V _____ mV	150.5 V Vout +300 mV		
High voltage (300 Vrms) Front Panel Measurement	299.30 V Vout -400 mV	_____ V _____ mV	300.7 V Vout +400 mV		
Agilent 6814B Current Measurement Accuracy					
Front Panel Measurement (10A)	Iout -60 mA	_____ mA	Iout +60 mA		
Agilent 6834B Current Measurement Accuracy					
Front Panel Measurement (5A)	Iout -30 mA	_____ mA	Iout +30 mA		
Agilent 6843A Current Measurement Accuracy					
Front Panel Measurement (15A)	Iout -65 mA	_____ mA	Iout +65 mA		

Performing the Calibration Procedure

Table B-1 lists the equipment required for calibration. Figure B-1 shows the test setup.

NOTE: You do not have to do a complete calibration each time. You may calibrate only the voltage or current and proceed to "Saving the Calibration Constants." However, before you calibrate OVP, you must first calibrate the output voltage.

The following parameters may be calibrated:

- ◆ ac output voltage
- ◆ realtime voltage (Agilent 6843A only)
- ◆ overvoltage protection (OVP)
- ◆ output voltage readback
- ◆ ac output current
- ◆ output current measurement (Agilent 6843A only)
- ◆ output impedance (Agilent 6843A only)

Before calibrating the output impedance on Agilent 6843A units, you must first calibrate the output voltage and the output current.

NOTE: The Agilent 6834A ac source must be calibrated in 3-phase output mode or an error will occur. To put the Agilent 6834B unit in 3-phase output mode, press **Address**, scroll to NOUTPUT 3 command, and press **Enter**.

Front Panel Calibration Menu

The Entry keypad is used for calibration functions.



Shift	Cal	Press this key to access the calibration menu.																										
		<table border="0" style="width: 100%;"> <thead> <tr> <th style="text-align: left;">Display</th> <th style="text-align: left;">Command Function</th> </tr> </thead> <tbody> <tr> <td>CAL ON <value></td> <td>Turns calibration mode on when the correct password value is entered.</td> </tr> <tr> <td>CAL OFF</td> <td>Turns calibration mode off</td> </tr> <tr> <td>CAL:LEV <char></td> <td>Advance to next step in sequence (P1, P2, P3, or P4).</td> </tr> <tr> <td>CAL:DATA <value></td> <td>Input a calibration measurement.</td> </tr> <tr> <td>CAL:VOLT:AC</td> <td>Begin ac voltage calibration sequence</td> </tr> <tr> <td>CAL:VOLT:PROT</td> <td>Begin voltage protection calibration</td> </tr> <tr> <td>CAL:CURR:AC</td> <td>Begin ac current calibration sequence</td> </tr> <tr> <td>CAL:CURR:MEAS</td> <td>Begin current measurement calibration sequence</td> </tr> <tr> <td>CAL:IMP</td> <td>Begin output impedance calibration sequence</td> </tr> <tr> <td>CAL:VOLT:RTIM¹</td> <td>Begin realtime voltage calibration</td> </tr> <tr> <td>CAL:SAVE</td> <td>Saves the calibration constants in non-volatile memory.</td> </tr> <tr> <td>CAL:PASS <value></td> <td>Set new calibration password.</td> </tr> </tbody> </table>	Display	Command Function	CAL ON <value>	Turns calibration mode on when the correct password value is entered.	CAL OFF	Turns calibration mode off	CAL:LEV <char>	Advance to next step in sequence (P1, P2, P3, or P4).	CAL:DATA <value>	Input a calibration measurement.	CAL:VOLT:AC	Begin ac voltage calibration sequence	CAL:VOLT:PROT	Begin voltage protection calibration	CAL:CURR:AC	Begin ac current calibration sequence	CAL:CURR:MEAS	Begin current measurement calibration sequence	CAL:IMP	Begin output impedance calibration sequence	CAL:VOLT:RTIM ¹	Begin realtime voltage calibration	CAL:SAVE	Saves the calibration constants in non-volatile memory.	CAL:PASS <value>	Set new calibration password.
Display	Command Function																											
CAL ON <value>	Turns calibration mode on when the correct password value is entered.																											
CAL OFF	Turns calibration mode off																											
CAL:LEV <char>	Advance to next step in sequence (P1, P2, P3, or P4).																											
CAL:DATA <value>	Input a calibration measurement.																											
CAL:VOLT:AC	Begin ac voltage calibration sequence																											
CAL:VOLT:PROT	Begin voltage protection calibration																											
CAL:CURR:AC	Begin ac current calibration sequence																											
CAL:CURR:MEAS	Begin current measurement calibration sequence																											
CAL:IMP	Begin output impedance calibration sequence																											
CAL:VOLT:RTIM ¹	Begin realtime voltage calibration																											
CAL:SAVE	Saves the calibration constants in non-volatile memory.																											
CAL:PASS <value>	Set new calibration password.																											



Notes:

¹ Agilent 6843A only

value = a numeric value

char = a character string parameter

Use  and  to scroll through the command list.

Use  and  to scroll through the parameter list.

Front Panel Calibration

WARNING *LETHAL VOLTAGES.* Ac sources can supply 425 V peak at their output. DEATH on contact may result if the output terminals or circuits connected to the output are touched when power is applied. These procedures must be performed by a qualified electronics technician or engineer trained on this equipment.

The following procedures assume you understand how to operate front panel keys (see Chapter 4).

Enable Calibration Mode

Action	Display
1. Reset the unit by selecting Shift, Output , and pressing Enter .	*RST
If you are calibration a 3-phase source , make sure that the default phase 1 ($\phi 1$) annunciator is lit. Press Phase Select to select a different phase.	
2. Press Shift Calibration , scroll to CAL ON, and press Enter .	CAL ON 0.0
3. Enter the calibration password from Entry keypad and press Enter . If the password is correct the Cal annunciator will come on.	
If CAL DENIED appears, then an internal switch has been set to prevent the calibration from being changed. (see the Service Manual.)	CAL DENIED
If the password is incorrect, an error occurs. If the active password is lost, the calibration function can be recovered by setting an internal switch that defeats password protection. (see the Service Manual.)	OUT OF RANGE

B - Verification and Calibration

Calibrating and Entering Voltage Calibration Values

Action	Display
4. Connect the DVM (ac volts mode) directly to the ac source via the ratio transformer shown in Figure B-1. Do not connect the load resistor or current shunt.	
5. Press Shift Calibration , scroll to CAL VOLT AC, and press Enter .	CAL:VOLT:AC
6. Press Shift Calibration , scroll to CAL LEV P1, and press Enter to select the first calibration point.	CAL:LEV P1
7. Press Shift Calibration , scroll to CAL DATA, and use the Entry keypad to enter the voltage value displayed on the DVM. (Multiply the DVM readings by the transformer ratio if a ratio transformer is used.)	CAL:DATA 0.00
8. Press Shift Calibration , scroll to CAL LEV P1, use ↓ to scroll to the P2 parameter, and press Enter . This selects the second calibration point.	CAL:LEV P2
9. Press Shift Calibration , scroll to CAL DATA, and use the Entry keypad to enter the voltage value displayed on the DVM. (Multiply the DVM readings by the transformer ratio if a ratio transformer is used.)	CAL:DATA 0.00
10. Press Shift Calibration , scroll to CAL LEV P1, use ↓ to scroll to the P3 parameter, and press Enter .	CAL:LEV P3
11. Press Shift Calibration , scroll to CAL DATA, and use the Entry keypad to enter the voltage value displayed on the DVM. (Multiply the DVM readings by the transformer ratio if a ratio transformer is used.)	CAL:DATA 0.00
12. Press Shift Calibration , scroll to CAL LEV P1, use ↓ to scroll to the P4 parameter, and press Enter .	CAL:LEV P4
13. Press Shift Calibration , scroll to CAL DATA, and use the Entry keypad to enter the voltage value displayed on the DVM. (Multiply the DVM readings by the transformer ratio if a ratio transformer is used.)	CAL:DATA 0.00

The ac source is now holding the new voltage calibration constants in RAM

Calibrating and entering realtime voltage calibration values (Agilent 6843A only)

14. Press Shift Calibration , scroll to CAL VOLT RTIM, and press Enter .	CAL:VOLT:RTIM
15. Press Shift Calibration , scroll to CAL LEV P1, and press Enter .	CAL:LEV P1
16. Press Shift Calibration , scroll to CAL DATA, and use the Entry keypad to enter the voltage value displayed on the DVM. (Multiply the DVM readings by the transformer ratio if a ratio transformer is used.)	CAL:DATA 0.00

Calibrating the OVP trip point

17. Press Shift Calibration , scroll to CAL VOLT PROT, and press Enter .	CAL:VOLT:PROT
18. Wait for the ac source to compute the OVP calibration constant. The display returns to Meter mode when the OVP calculation is complete.	

The ac source is now holding the new OVP calibration constants in RAM

19. **If you are calibrating a 3-phase source**, press **Phase Select** to select the next phase and repeat steps 4 through 13 and 17 and 18 for phases 2 and 3. The phase annunciators on the front panel indicate which phase is active.

Calibrating and Entering Current Calibration Values

Action	Display
20. Connect the appropriate current shunt and load resistor as shown in figure B-1. Connect the DVM (ac rms mode) across the current shunt. If you are calibrating a 3-phase source , make sure that the default phase 1 ($\phi 1$) annunciator is lit. Press Phase Select to select a different phase.	
21. Press Shift Calibration , scroll to CAL CURR AC, and press Enter .	CAL:CURR:AC
22. Press Shift Calibration , scroll to CAL LEV P1, and press Enter .	CAL:LEV P1
23. Press Shift Calibration and scroll to CAL DATA. Wait for the DVM reading to stabilize. Read the DVM and calculate the first current value (DVM ac rms voltage divided by the shunt resistance). Use the Entry keypad to enter the rms current value.	CAL:DATA 0.00
24. Press Shift Calibration , scroll to CAL LEV P1, use \blacktriangledown to scroll to the P2 parameter, and press Enter .	CAL:LEV P2
25. Press Shift Calibration and scroll to CAL DATA. Wait for the DVM reading to stabilize. Read the DVM and calculate the second current value (DVM ac rms voltage divided by the shunt resistance). Use the Entry keypad to enter the rms current value.	CAL:DATA 0.00
26. If you are calibrating a 3-phase source , press Phase Select to select the next phase and repeat steps 20 through 25 for phases 2 and 3. The phase annunciators on the front panel indicate which phase is active.	

Calibrating and entering rms current measurement values (Agilent 6843A only)

27. Press Shift Calibration , scroll to CAL CURR MEAS, and press Enter .	CAL:CURR:MEAS
28. Press Shift Calibration , scroll to CAL LEV P1, and press Enter .	CAL:LEV P1
29. Press Shift Calibration and scroll to CAL DATA. Wait for the DVM reading to stabilize. Read the DVM and calculate the first current value (DVM ac rms voltage divided by the shunt resistance). Use the Entry keypad to enter the rms current value.	CAL:DATA 0.00
30. Press Shift Calibration , scroll to CAL LEV P1 command, use \blacktriangledown to scroll to the P2 parameter, and press Enter .	CAL:LEV P2
31. Press Shift Calibration and scroll to the CAL DATA. Wait for the DVM reading to stabilize. Read the DVM and calculate the second current value (DVM ac rms voltage divided by the shunt resistance). Use the Entry keypad to enter the rms current value.	CAL:DATA 0.00

The ac source is now holding the new current calibration constants in RAM

Calibrating the Output Impedance (Agilent 6843A only)

NOTE: The output voltage and output current must be calibrated before the output impedance can be calibrated.

Action	Display
32. Connect only the output impedance resistor across the output of the ac source. Do not connect any other equipment.	
33. Press Shift Calibration , scroll to the CAL IMP command, and press Enter .	CAL:IMP
34. Wait for the ac source to compute the output impedance calibration constant. The display returns to Meter mode when the calculation is complete.	

The ac source is now holding the new impedance calibration constants in RAM

Saving the Calibration Constants

CAUTION: Storing calibration constants overwrites the existing ones in non-volatile memory. If you are not sure you want to permanently store the new constants, omit this step. The ac source calibration will then remain unchanged.

Action	Display
35. Press Shift Calibration , scroll to CAL SAVE, and press Enter .	CAL:SAVE
36. Press Shift Calibration , select CAL OFF, and press Enter to exit Calibration mode. *RST and *RCL will also set the calibration state to OFF.	CAL OFF

Changing the Calibration Password

The factory default password is 0. You can change the password when the ac source is in calibration mode (which requires you to enter the existing password). Proceed as follows:

Action	Display
1. Begin by pressing Shift Calibration and scrolling to the CAL ON command.	CAL ON 0.0
2. Enter the existing password from Entry keypad and press Enter	
3. Press Shift Calibration and scroll to the CAL PASS command.	CAL:PASS 0
4. Enter the new password from the keypad. You can use any number with up to six digits and an optional decimal point. If you want the calibration function to operate without requiring any password, change the password to 0 (zero).	

NOTE: If you want the calibration function to operate without requiring any password, change the password to 0 (zero).

Calibration Error Messages

Errors that can occur during calibration are shown in the following table.

Table B-3. GPIB Calibration Error Messages

Error	Meaning
401	CAL switch prevents calibration (This is a hardware disable, see the ac source Service Manual.)
402	CAL password is incorrect
403	CAL not enabled
404	Computed readback cal constants are incorrect
405	Computed programming cal constants are incorrect
406	Incorrect sequence of calibration commands

Calibration Over the GPIB

You can calibrate the ac source by using SCPI commands within your controller programming statements. Be sure you are familiar with calibration from the front panel before you calibrate from a controller. Each front panel calibration command has a corresponding SCPI command.

The SCPI calibration commands are explained in Chapter 3 of the ac source Programming Guide. Calibration error messages that can occur during GPIB calibration are shown in table B-3.

Agilent Calibration Program Listing

Figure B-2 lists the calibration program. This program can be run on any controller operating under Agilent BASIC. The assumed power supply address is 705 and calibration password is 0. If required, change these parameters in the appropriate statements.

B - Verification and Calibration

```
10      !
20      ! AC Source calibration program                      Rev B.00.00
30      !
40      ASSIGN @Ac TO 705
50      !
60      PRINT TABXY(3,3),"This program will calibrate the 6814B/34B/43A AC Power Solutions."
70      PRINT TABXY(3,5),"Equipment requirements are: Agilent3458A or equivalent DVM"
80      PRINT TABXY(35,6),"0.01 ohm <200ppm Current Shunt for 6814B/6834B"
90      PRINT TABXY(35,7),"0.001 ohm <200ppm Current Shunt for 6843A"
100     PRINT TABXY(35,8),"0 - 5 ohm > 4.8 kW power resistor for 6843A"
110     PRINT TABXY(35,9),"2 - 15 ohm > 1.5 kW power resistor for 6814B/6834B"
120     PRINT TABXY(35,10),"1 - 1 ohm > 100 watt impedance resistor for 6843A"
130     PRINT TABXY(35,11),"30:1 <50ppm Ratio Transformer"
140     PRINT TABXY(3,13),"Ratio Transformer is required when calibrating to MIL-STD-45662A. If the ratio"
150     PRINT TABXY(3,14),"transformer is not used, the measurement uncertainty must be recalculated."
160     PRINT TABXY(3,16),"IF YOU ARE CALIBRATING A 6843B, SELECT THE PHASE TO CALIBRATE USING THE FRONT"
170     PRINT TABXY(3,17),"PANEL KEYPAD.      *** NOTE: THIS PROGRAM WILL ONLY CALIBRATE 1 PHASE. ***"
180     PRINT TABXY(3,18),"YOU MUST RUN THIS PROGRAM 3 TIMES TO CALIBRATE ALL PHASES OF A 6843B."
190     DISP "Press CONT to continue"
200     PAUSE
210     CLEAR SCREEN
220     PRINT TABXY(10,5),"1. Turn the AC Source off"
230     PRINT TABXY(10,7),"2. Disconnect all loads"
240     PRINT TABXY(10,9),"3. Connect the 3458A to the rear terminal block"
250     PRINT TABXY(10,11),"4. Set the 3458A to AC VOLTS"
260     PRINT TABXY(10,13),"5. Turn on the AC Source"
270     !
280     DISP "Press CONT to begin AC PROGRAMMING and MEASUREMENT calibration"
290     PAUSE
300     CLEAR SCREEN
310     PRINT TABXY(18,5),"CALIBRATING AC POGRAMMING and MEASUREMENT"
320     PRINT TABXY(20,7),"There are 4 points to be calibrated"
330     OUTPUT @Ac;"CAL:STATE:ON"
340     OUTPUT @Ac;"CAL:VOLT:AC"
350     OUTPUT @Ac;"CAL:LEV P1"
360     WAIT 10
370     INPUT "Enter AC rms ( transformer ratio * DVM reading)",Ac_p1
380     PRINT TABXY(25,9),"Point 1 entered"
390     OUTPUT @Ac;"CAL:DATA";Ac_p1
400     OUTPUT @Ac;"CAL:LEV P2"
410     WAIT 10
420     INPUT "Enter AC rms ( transformer ratio * DVM reading)",Ac_p2
430     PRINT TABXY(25,11),"Point 2 entered"
440     OUTPUT @Ac;"CAL:DATA";Ac_p2
450     OUTPUT @Ac;"CAL:LEV P3"
460     WAIT 10
470     INPUT "Enter AC rms ( transformer ratio * DVM reading)",Ac_p3
480     PRINT TABXY(25,13),"Point 3 entered"
490     OUTPUT @Ac;"CAL:DATA";Ac_p3
500     OUTPUT @Ac;"CAL:LEV P4"
510     WAIT 10
520     INPUT "Enter AC rms ( transformer ratio * DVM reading)",Ac_p4
530     PRINT TABXY(25,15),"Point 4 entered"
540     OUTPUT @Ac;"CAL:DATA";Ac_p4
550     WAIT 3
560     CLEAR SCREEN
570     !
580     ! Only include lines 580 - 690 if calibrating Agilent 6843
590     !
600     PRINT TABXY(18,5),"CALIBRATING REALTIME VOLTAGE (Agilent 6834A ONLY)"
610     PRINT TABXY(20,7),"There is 1 point to be calibrated"
620     OUTPUT @Ac;"CAL:VOLT:RTIM"
630     OUTPUT @Ac;"CAL:LEV P1"
640     WAIT 10
650     INPUT "Enter realtime rms ( transformer ratio * DVM reading)",Rt_p1
660     PRINT TABXY(25,9),"Point 1 entered"
670     OUTPUT @Ac;"CAL:DATA";Rt_p1
680     WAIT 3
690     CLEAR SCREEN
```

Figure B-2. Calibration Program Listing (Sheet 1 of 2)

```

700 PRINT TABXY(15,10),"CALIBRATING OVERVOLTAGE PROTECTION"
710 OUTPUT @Ac;"CAL:VOLT:PROT"
720 PRINT TABXY(30,15),"WAIT"
730 WAIT 30
740 OUTPUT @Ac;"CAL:SAVE"
750 OUTPUT @Ac;"CAL:STATE OFF"
760 CLEAR SCREEN
770 PRINT TABXY(15,5),"1. Turn off the AC Source"
780 PRINT TABXY(15,7),"2. Connect the current shunt and load resistor, see fig.B-1"
790 PRINT TABXY(15,9),"3. Connect the 3458A across the current shunt"
800 PRINT TABXY(15,11),"4. Set the 3458A to AC rms VOLTS"
810 PRINT TABXY(15,13),"5. Turn on the AC Source"
820 !
830 DISP "Press CONT to begin Current Program and Measurement calibration"
840 PAUSE
850 CLEAR SCREEN
860 PRINT TABXY(22,5),"CALIBRATING CURRENT POGRAMMING"
870 PRINT TABXY(20,7),"There are 2 points to be calibrated"
880 OUTPUT @Ac;"CAL:STATE ON"
890 OUTPUT @Ac;"CAL:CURR:AC"
900 OUTPUT @Ac;"CAL:LEV P1"
910 WAIT 10
920 INPUT "Enter AC rms current ( DVM reading divided by shunt resistance )",Ai_p1
930 PRINT TABXY(25,9),"Point 1 entered"
940 OUTPUT @Ac;"CAL:DATA";Ai_p1
950 OUTPUT @Ac;"CAL:LEV P2"
960 WAIT 10
970 INPUT "Enter AC rms current ( DVM reading divided by shunt resistance )",Ai_p2
980 PRINT TABXY(25,11),"Point 2 entered"
990 OUTPUT @Ac;"CAL:DATA";Ai_p2
1000 WAIT 3
1010 CLEAR SCREEN
1020 !
1030 ! Only include lines 1030 - 1340 if calibrating Agilent 6843
1040 !
1050 PRINT TABXY(22,5),"CALIBRATING CURRENT MEASUREMENT (Agilent 6843A ONLY)"
1060 PRINT TABXY(20,7),"There are 2 points to be calibrated"
1070 OUTPUT @Ac;"CAL:CURR:MEAS"
1080 OUTPUT @Ac;"CAL:LEV P1"
1090 WAIT 10
1100 INPUT "Enter AC rms current ( DVM reading divided by shunt resistance )",Am_p1
1110 PRINT TABXY(25,9),"Point 1 entered"
1120 OUTPUT @Ac;"CAL:DATA";Am_p1
1130 OUTPUT @Ac;"CAL:LEV P2"
1140 WAIT 10
1150 INPUT "Enter AC rms current ( DVM reading divided by shunt resistance )",Am_p2
1160 PRINT TABXY(25,11),"Point 2 entered"
1170 OUTPUT @Ac;"CAL:DATA";Am_p2
1180 WAIT 3
1190 CLEAR SCREEN
1200 OUTPUT @Ac;"CAL:SAVE"
1210 OUTPUT @Ac;"CAL:STATE OFF"
1220 PRINT TABXY(15,5),"1. Turn off the AC Source"
1230 PRINT TABXY(15,7),"2. Disconnect all equipment from the AC Source"
1240 PRINT TABXY(15,9),"3. Connect the 1 ohm impedance resistor, see fig.B-1"
1250 PRINT TABXY(15,11),"4. Turn on the AC Source"
1260 !
1270 DISP "Press CONT to begin Output Impedance calibration"
1280 PAUSE
1290 PRINT TABXY(15,10),"CALIBRATING OUTPUT IMPEDANCE (Agilent 6843A ONLY)"
1300 OUTPUT @Ac;"CAL:STATE ON"
1310 OUTPUT @Ac;"CAL:IMP"
1320 PRINT TABXY(30,15),"WAIT"
1330 WAIT 30
1340 !
1350 OUTPUT @Ac;"CAL:SAVE"
1360 OUTPUT @Ac;"CAL:STATE OFF"
1370 CLEAR SCREEN
1380 PRINT TABXY(25,10),"CALIBRATION COMPLETE"
1390 END

```

Figure B-2. Calibration Program Listing (Sheet 2 of 2)

Error Messages

Error Number List

This appendix gives the error numbers and descriptions that are returned by the ac source. Error numbers are returned in two ways:

- ◆ Error numbers are displayed on the front panel
- ◆ Error numbers and messages are read back with the `SYSTEM:ERRor?` query. `SYSTEM:ERRor?` returns the error number into a variable and returns two parameters: an NR1 and a string.

The following table lists the errors that are associated with SCPI syntax errors and interface problems. It also lists the device dependent errors. Information inside the brackets is not part of the standard error message, but is included for clarification. When errors occur, the Standard Event Status register records them in bit 2, 3, 4, or 5:

Table C-1. Error Numbers

Error Number	Error String [Description/Explanation/Examples]
	Command Errors –100 through –199 (sets Standard Event Status Register bit #5)
–100	Command error [generic]
–101	Invalid character
–102	Syntax error [unrecognized command or data type]
–103	Invalid separator
–104	Data type error [e.g., "numeric or string expected, got block data"]
–105	GET not allowed
–108	Parameter not allowed [too many parameters]
–109	Missing parameter [too few parameters]
–112	Program mnemonic too long [maximum 12 characters]
–113	Undefined header [operation not allowed for this device]
–121	Invalid character in number [includes "9" in octal data, etc.]
–123	Numeric overflow [exponent too large; exponent magnitude >32 k]
–124	Too many digits [number too long; more than 255 digits received]
–128	Numeric data not allowed
–131	Invalid suffix [unrecognized units, or units not appropriate]
–138	Suffix not allowed
–141	Invalid character data [bad character, or unrecognized]
–144	Character data too long
–148	Character data not allowed
–150	String data error
–151	Invalid string data [e.g., END received before close quote]
–158	String data not allowed
–160	Block data error
–161	Invalid block data [e.g., END received before length satisfied]
–168	Block data not allowed
–170	Expression error

C - Error Messages

-171	Invalid expression
-178	Expression data not allowed
	Execution Errors –200 through –299 (sets Standard Event Status Register bit #4)
-200	Execution error [generic]
-221	Settings conflict [check current device state]
-222	Data out of range [e.g., too large for this device]
-223	Too much data [out of memory; block, string, or expression too long]
-224	Illegal parameter value [device-specific]
-225	Out of memory
-270	Macro error
-272	Macro execution error
-273	Illegal macro label
-276	Macro recursion error
-277	Macro redefinition not allowed
	System Errors –300 through –399 (sets Standard Event Status Register bit #3)
-310	System error [generic]
-350	Too many errors [errors beyond 9 lost due to queue overflow]
	Query Errors –400 through –499 (sets Standard Event Status Register bit #2)
-400	Query error [generic]
-410	Query INTERRUPTED [query followed by DAB or GET before response complete]
-420	Query UNTERMINATED [addressed to talk, incomplete programming message received]
-430	Query DEADLOCKED [too many queries in command string]
-440	Query UNTERMINATED [after indefinite response]
	Selftest Errors 0 through 99 (sets Standard Event Status Register bit #3)
0	No error
1	Non-volatile RAM RD0 section checksum failed
2	Non-volatile RAM CONFIG section checksum failed
3	Non-volatile RAM CAL section checksum failed
4	Non-volatile RAM WAVEFORM section checksum failed
5	Non-volatile RAM STATE section checksum failed
6	Non-volatile RAM LIST section checksum failed
7	Non-volatile RAM RST section checksum failed
10	RAM selftest
11 - 31	DAC selftest error, expected <n>, read <reading> Errors 11, 12, 13, 14, 15 apply to DAC12 1A and 1B Errors 16, 17, 18 apply to DAC12 2A Errors 19, 20, 21 apply to DAC12 2B Errors 22, 23 apply to DAC12 4A Errors 24, 25 apply to DAC12 4B Errors 26, 27, 28 apply to DAC12 3A and 3B Errors 29, 30, 31 apply to DAC12 5A and 5B
40	Voltage selftest error, output 1

41	Voltage selftest error, output 2
42	Voltage selftest error, output 3
43	Current selftest error, output 1
44	Current selftest error, output 2
45	Current selftest error, output 3
70	Fan voltage failure
80	Digital I/O selftest error
Device-Dependent Errors 100 through 32767 (sets Standard Event Status Register bit #3)	
200	Outgrd not responding
201	Front panel not responding
210	Ingrd receiver framing error
211	Ingrd uart overrun status
212	Ingrd received bad token
213	Ingrd receiver buffer overrun
214	Ingrd input buffer overrun
215	Outgrd output buffer overrun
216	RS-232 receiver framing error
217	RS-232 receiver parity error
218	RS-232 receiver overrun error
219	Ingrd inbuf count sync error
220	Front panel uart overrun
221	Front panel uart framing
222	Front panel uart parity
223	Front panel buffer overrun
224	Front panel timeout
401	CAL switch prevents calibration
402	CAL password is incorrect
403	CAL not enabled
404	Computed readback cal constants are incorrect
405	Computed programming cal constants are incorrect
406	Incorrect sequence of calibration commands
600	Systems in mode:list have different list lengths
601	Requested voltage and waveform exceeds peak voltage capability
602	Requested voltage and waveform exceeds transformer volt-second rating
603	Command only applies to RS-232 interface
604	Trigger received before requested number of pre-trigger readings
605	Requested RMS current too high for voltage range
606	Waveform data not defined
607	VOLT, VOLT:SLEW, and FUNC:SHAP modes incompatible
608	Measurement overrange
609	Output buffer overrun
610	Command cannot be given with present SYST:CONF setting

Index

—A—

- accessories, 10
- airflow, 16
- annunciators
 - φ1, 32
 - Addr, 32
 - Cal, 32
 - CC, 32
 - CV, 32
 - Dis, 32
 - Err, 32
 - OCP, 32
 - Prot, 32
 - Rmt, 32
 - Shift, 32
 - SRQ, 32
 - Tran, 32
 - Unr, 32
- AWG ratings, 19

—C—

- cables, 10
- calibration, 62
 - enable, 63
 - equipment, 59
 - error messages, 67
 - menu, 63
 - output impedance, 66
 - password, 66
 - program listing, 67
 - rms current, 65
 - saving, 66
 - setup, 60
 - voltage offset, 64
- capabilities, 11
- cleaning, 15

—D—

- damage, 15
- digital connections, 21
- digital connector, 15
- dimensions, 16

—E—

- entry keys, 40
 - ←, 40
 - 0 ... 9, 40
 - Clear Entry, 40
 - E, 40
 - Enter, 40
- error messages, 29

- error numbers, 71

—F—

- features, 11
- Fixed, 44
- FLT connections, 21
- frequency control, 12
- front panel, 31
 - annunciators, 32
 - controls and indicators, 12, 31
 - keys, 32
- function keys, 34
 - ▲, 34, 35
 - ▲ Index, 34
 - immediate action, 34
 - Output On/Off, 34
 - Phase Select, 34
 - Trigger, 34
- fuses, 17

—G—

- general information, 9
- ground, earth, 10
- guide, programming, 9
- guide, user's, 9

—H—

- hazardous voltages, 59
- history, 6
- HP-IB, 53
 - address, 53
 - connections, 22

—I—

- INH connections, 21
- input
 - connections, 17
 - power, 10
- inspection, 15

—L—

- lethal voltages, 59
- line fuse
 - replacing, 29
- List, 44, 46
- load voltage drops, 19
- location, 16

Index

—M—

manuals, 9, 15
Meter AC+DC, 32
meter display keys
 Harmonic, 35
 Input, 35
 Meter, 35

—N—

non-volatile memory
 clearing, 53
 storing, 33

—O—

operating features, 11
options, 10
output
 characteristic, 12
 connections, 19
 connector, 15
 rating, 12
 setting output protection, 43
 setting the amplitude, 41, 54
 setting the frequency, 43
Output AC+DC, 32
output checkout, 26
output control keys
 Current, 36
 Freq, 36
 Voltage, 36
OVLd, 29

—P—

Peak Inrush current
 measuring, 52
Phase synchronization, 47
power cord, 15
 installation, 17
power receptacle, 10
preliminary checkout, 25
print date, 6
program listing
 calibration, 67
protection/status keys
 Protect, 38
 Status, 38
Pulse, 45

—R—

rack mount kit, 10
rack mounting, 16
recalling operating states, 53
remote programming, 12
remote sensing, 20
 OVP considerations, 21
repacking, 15

RS-232, 53
 connections
 interface commands, 23
 data format, 23
 handshake, 24
 pinouts, 23

—S—

safety class, 10
safety summary, 3
safety warning, 10
saving operating states, 53
self-test, 25
selftest errors, 29
sense connections, 20
service guide, 10
shift annunciator, 26
shift key, 26
Slew rates
 programming, 50
specifications, 55
Step, 44
supplemental characteristics, 56
SYSTEM
 LOCAL, 23
 REMOte, 23
 RWLOCK, 23
system errors, 71
system keys, 33
 Address, 33
 Error, 33
 Interface, 33
 Local, 33
 RCL, 33
 Save, 33
 Shift, 33

—T—

transient voltage
 fixed, 44
 list, 44, 46
 pulse, 45
 step, 44
transient voltage mode, 44
trigger connections, 21
Trigger delays, 47
trigger IN, 21
trigger OUT, 21
trigger/list keys
 List, 39
 Trigger Control, 39
turn-on checkout, 25, 60

—V—

verification, 26
 ac measurement accuracy, 61
 ac voltage programming, 61
 equipment, 59

- rms current accuracy, 61
 - setup, 60
 - test record, 62
- verification tests, 25
- voltage control, 12

—W—

- warranty, 2
- Waveform
 - generation, 50
- wire
 - current ratings, 19
- wiring considerations, 19

Agilent Sales and Support Offices

For more information about Agilent Technologies test and measurement products, applications, services, and for a current sales office listing, visit our web site:

<http://www.agilent.com/find/tmdir>

You can also contact one of the following centers and ask for a test and measurement sales representative.

United States:

Agilent Technologies
Test and Measurement Call Center
P.O. Box 4026
Englewood, CO 80155-4026
(tel) 1 800 452 4844

Latin America:

Agilent Technologies
Latin American Region Headquarters
5200 Blue Lagoon Drive, Suite #950
Miami, Florida 33126
U.S.A.
(tel) (305) 267 4245
(fax) (305) 267 4286

Canada:

Agilent Technologies Canada Inc.
5150 Spectrum Way
Mississauga, Ontario
L4W 5G1
(tel) 1 877 894 4414

Australia/New Zealand:

Agilent Technologies Australia Pty Ltd
347 Burwood Highway
Forest Hill, Victoria 3131
(tel) 1-800 629 485 (Australia)
(fax) (61 3) 9272 0749
(tel) 0 800 738 378 (New Zealand)
(fax) (64 4) 802 6881

Europe:

Agilent Technologies
Test & Measurement European Marketing Organisation
P.O. Box 999
1180 AZ Amstelveen
The Netherlands
(tel) (31 20) 547 9999

Asia Pacific:

Agilent Technologies
24/F, Cityplaza One, 1111 King's Road,
Taikoo Shing, Hong Kong
tel: (852)-3197-7777
fax: (852)-2506-9284

Japan:

Agilent Technologies Japan Ltd.
Measurement Assistance Center
9-1, Takakura-Cho, Hachioji-Shi,
Tokyo 192-8510, Japan
(tel) (81) 426 56 7832
(fax) (81) 426 56 7840

Technical data is subject to change.

Manual Updates

The following updates have been made to this manual since the print revision indicated on the title page.

4/15/00

All references to HP have been changed to Agilent.

All references to HP-IB have been changed to GPIB.