

---

# I/O Function Guide

Publication number 54652-97004

August 2000

© Copyright Agilent Technologies 1991-1996, 2000  
All rights reserved

---

## Interface Modules for Agilent 54600-Series Instruments

---

## Contents

To install the interface module	6
Print/Utility Menu	8
To select your printer or plotter.	9
To setup your printer or plotter	11
To set formfeed	12
To print or plot gray scale	13
Gray scale printing	13
Gray scale plotting	14
To print or plot scale factors	15
To set GPIB addresses	17
Instrument address	17
Printer Address	17
To set RS-232 baud rate and handshake	18
Baud rate	18
Handshake	18

---

# Introduction

These modules provide the means for remote communication with Agilent 54600-series instruments. For programming specifics, refer to the Programmer's Guide or Programmer's Reference shipped with your oscilloscope or logic analyzer. The hardcopy process does not interrupt front-panel operation of the instrument. While any of the interfaces are connected to the rear panel of the instrument, the instruments trace memories become nonvolatile and are saved when the power is removed from the instrument.

## **Agilent 54650A GPIB Interface Module**

- Full programmability
- Hardcopy output

## **Agilent 54651A RS-232-C Interface Module**

- Full programmability
- Hardcopy output

## **Agilent 54652A Parallel Interface Module**

- Hardcopy output

## **Agilent 54652B Parallel/RS-232-C Interface Module**

- Full programmability
- Hardcopy output
- Connection to both an RS-232-C controller and a parallel printer at the same time.

## **Agilent 54655A Test Automation Module (GPIB) and Agilent 54656A Test Automation Module (RS-232-C)**

- Full programmability.
- Hardcopy output.
- 100 nonvolatile sequence steps.
- 40 nonvolatile mask templates.

- 2 nonvolatile trace memories.
- Built-in automatic mask generation and mask editing capabilities.
- Protection of test sequence and mask template setup through software.

The Agilent 54656A has the following additional features:

- External input lines for Next, Previous and Reset control.
- 5 user-definable output lines.
- Recessed protection switch.

**Agilent 54657A Measurement/Storage Module (GPIB),  
Agilent 54658A Measurement/Storage Module (RS-232-C), and  
Agilent 54659B Measurement/Storage Module (RS-232-C/Parallel)**

- Full programmability.
- Hardcopy output.
- Three additional automatic voltage measurements (amplitude, preshoot, and overshoot).
- Two additional automatic time measurements (delay and phase angle).
- User defined measurement thresholds of 10%/90%, 20%/80%, or selected voltage values.
- Two additional cursor measurements (voltage in percent and time in degrees).
- Two additional cursor measurement sources (math function 1 and 2).
- Waveform math functions (addition, subtraction, multiplication, differentiation, integration, and FFT).
- Time and date tagging of hardcopy and nonvolatile memories.
- Three nonvolatile trace memories.
- Additional 64K of nonvolatile trace memory (with data compression).

The Agilent 54659B has an additional parallel output connector which allows the module to be connected to both an RS-232-C controller and a parallel printer at the same time.

---

**Interface I/O functions**

---

<b>Agilent Interface module</b>	<b>Interface connection</b>	<b>I/O Function</b>
<b>54650A</b>	GPIB	GPIB controller <u>or</u> GPIB output to printer/plotter
<b>54651A</b>	RS-232-C	RS-232-C controller <u>or</u> RS-232-C output to printer/plotter
<b>54652A</b>	Parallel	Parallel output to printer
<b>54652B<sup>2</sup></b>	RS-232-C and parallel	RS-232-C controller <u>and</u> parallel output to printer, or RS-232-C output to printer/plotter
<b>54655A<sup>1,3</sup></b>	GPIB	GPIB controller <u>or</u> GPIB output to printer/plotter
<b>54656A<sup>1,3</sup></b>	RS-232-C	RS-232-C controller <u>or</u> RS-232-C output to printer/plotter
<b>54657A<sup>1</sup></b>	GPIB	GPIB controller <u>or</u> GPIB output to printer/plotter
<b>54658A<sup>1</sup></b>	RS-232-C	RS-232-C controller <u>or</u> RS-232-C output to printer/plotter
<b>54659B<sup>1,2</sup></b>	RS-232-C and parallel	RS-232-C controller <u>and</u> parallel output to printer, or RS-232-C output to printer/plotter

<sup>1</sup> The enhanced features of the 54655A/56A/57A/58A/59B are not available to the 54620A/C Logic Analyzer. These modules supply enhanced oscilloscope programming functions. The I/O functions of these modules will function when used with the 54620A/C Logic Analyzer.

<sup>2</sup> The 54652B and 54659B are not compatible with the 54600A, 54601A, 54602A, and 54610A.

<sup>3</sup> The 54655A and 54656A are not compatible with the 54615B, 54615B, 54645A, and 54645D.

---

## To install the interface module

- 1 Turn off the instrument.
- 2 Install the module as shown below.

The instrument is reset after installation. The installed interface module is shown in the message displayed when your turn on the instrument. The I/O functions (controller and hardcopy) are available by pressing the instrument front-panel **Print/Utility** key.

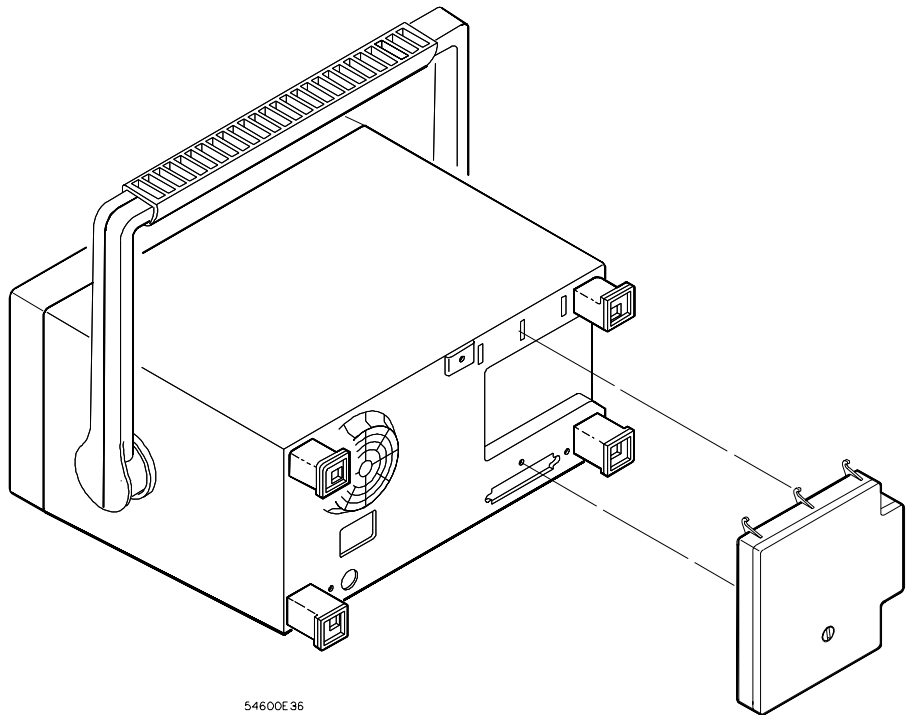

Installation of interface module to Agilent 54600-Series instrument

## Interface Cables

Agilent Interface module	Cable function (Instrument to ..)	Module connector	Printer/plotter/ controller connector	Agilent part number	Cable Length
<b>54650A, 54655A<sup>1,3</sup>, 54657A<sup>1</sup> (GPIB)</b>	Printer/plotter/ controller	GPIB	GPIB	10833A	1 m (3.3 ft)
				10833B	2 m (6.6 ft)
				10833C	4 m (13.2 ft)
				0833D	0.5 m (1.6 ft)
<b>54651A, 54656A<sup>1,3</sup>, 54658A<sup>1</sup> (RS-232-C)</b>	Printer/plotter/ controller	25-pin F	25-pin F	13242G	5 m (16.7 ft)
				17255M	1.5 m (4.9 ft)
				Controller	25-pin F
	Controller			17255D	1.5 m (4.9 ft)
	Controller	25-pin F	9-pin M	24542G	3 m (9.9 ft)
<b>54652A (parallel output only)</b>	Parallel printer	parallel	parallel	C2950A	2 m (6.6 ft)
				C2951A	3 m (9.9 ft)
<b>54652B<sup>2</sup>, 54659B<sup>1,2</sup> (RS-232-C and parallel output)</b>	RS-232-C controller	9-pin M	25-pin M	34398A	2.5 m (8.2 ft)
	RS-232-C controller	9-pin M	9-pin M	34398A	2.5 m (8.2 ft)
	RS-232-C printer/ plotter/controller	9-pin M	25-pin F	34398A + 34399A adapter kit	2.5 m (8.2 ft)
	Parallel printer	parallel	parallel	C2950A	2 m (6.6 ft)
				C2951A	3 m (9.9 ft)

<sup>1</sup> The enhanced features of the 54655A/56A/57A/58A/59B are not available to the 54620A/C Logic Analyzer. These modules supply enhanced oscilloscope programming functions. The I/O functions of these modules will function when used with the 54620A/C Logic Analyzer.

<sup>2</sup> The 54652B and 54659B are not compatible with the 54600A, 54601A, 54602A, and 54610A.

<sup>3</sup> The 54655A and 54656A are not compatible with the 54615B , 54615B, 54645A and 54645D.

---

# Print/Utility Menu

The Print/Utility menu of your Agilent 54600-series instrument allows you to select I/O functions for the module you have connected to your instrument. The module can have an GPIB, RS-232-C, parallel, or combination RS-232-C/parallel interface.

- To display this menu, press **Print/Utility** .

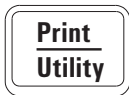

## Print/Utility Menu

**Print Screen** pressing this softkey sends the screen image to your printer or plotter.

### Interface setup

In many cases, the interface will need to be configured before attempting to print. If you are setting up an GPIB module, refer to "To set GPIB addresses" on page 17. If you are setting up an RS-232-C module, refer to "To set RS-232 baud rate and handshake" on page 18.

**Hardcopy Menu** this softkey allows you to select your printer or plotter type and to set parameters for that printer or plotter.

**I/O Menu** this softkey allows you to set up parameters for your RS-232-C or GPIB interface for printer or controller operation.

**Service Menu** and **System Config** these softkeys control instrument and enhanced module functions such as service self-test, service self-calibration and system configuration. Refer to your instrument *User and Service Guide* or enhanced module *User's Guide* for use of these softkeys.



---

## To select your printer or plotter

- Press the **Hardcopy Menu** softkey to view printer/plotter options. Your module can be configured to print in several formats.
- To select the format of your printer/plotter, press the **Format** softkey until the desired format is displayed.



### Hardcopy Menu with RS-232-C or parallel module attached

**Format** Your module can be configured to print in the following formats:

**LaserJet** HP LaserJet format

**DJ mono** monochrome HP DeskJet format

**DJ color** color HP DeskJet format (color Agilent 54600-series instruments only)

**Epson** Epson format

**ThinkJet** HP ThinkJet format (GPIB and RS-232-C modules only)

**Plotter** HP plotter (HP-GL) format. This format is available on GPIB and RS-232-C modules only and is not an option on color Agilent 54600 instruments.

I/O Function Guide  
To select your printer or plotter.

**Destination** If you have an RS-232-C/parallel dual interface module, press the **Destination** softkey to select the hardcopy output destination of the module to be **RS-232** or **Parallel**.

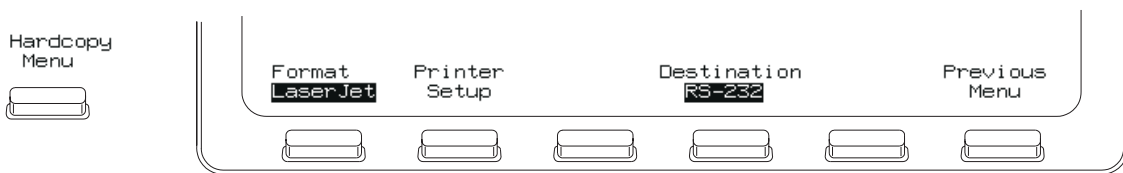

**Hardcopy Menu with RS-232-C/parallel dual interface module attached**

**Printer address** If you have a GPIB interface module, press the **PrintAddr** softkey until the correct address is displayed. The address can also be incremented or decremented by turning the knob closest to the **Cursors** key. The default printer/plotter address is 1.

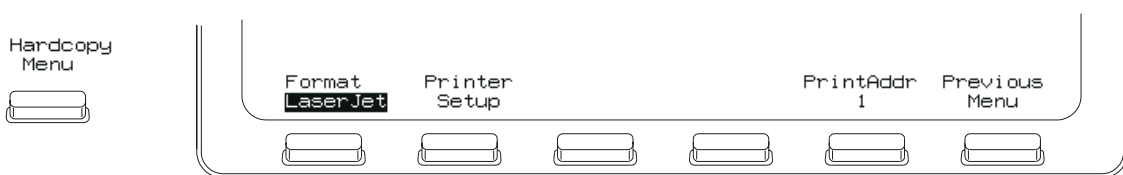

**Hardcopy Menu with GPIB module attached**

---

## To setup your printer or plotter

- From the **Hardcopy Menu**, press the **Printer Setup** softkey.



### Selecting Printer Setup from the Hardcopy Menu

Printer/plotter options are displayed for formfeed, scale factors, and gray scale printing.

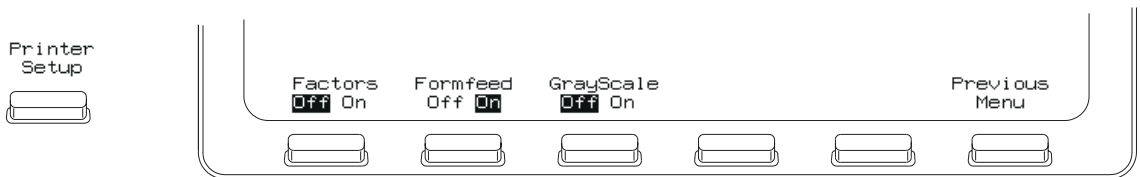

### Printer setup options for Agilent LaserJet and Agilent DeskJet formats

---

## To set formfeed

- To set formfeed, press the **Hardcopy Menu** softkey, then the **Printer Setup** softkey. **Formfeed** can be selected as **On** or **Off**

The instrument will send a formfeed command after printing when **Formfeed** is set to **On**.

Formfeed is not an option when **Format** is set to **Plotter**.

## To print or plot gray scale

### Gray scale printing

- To print in gray scale, press the **Hardcopy Menu** softkey, then the **Printer Setup** softkey. **GrayScale** can be selected as **On** or **Off**

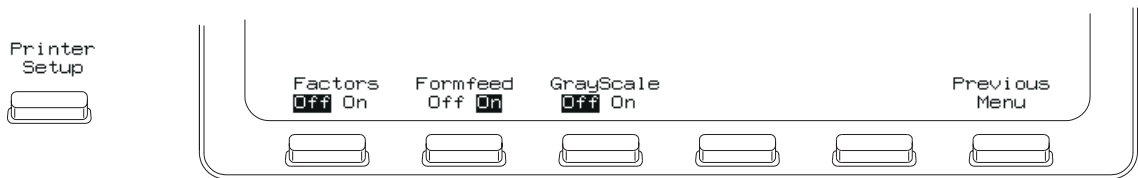

### Selecting GrayScale from the Printer Setup menu

When gray scale printing is selected, the full-bright and half-bright traces on the instrument screen are printed on the hardcopy.

Gray scale printing requires an HP-PCL printer capable of at least 300 dpi (dots-per-inch), such as an HP LaserJet or HP DeskJet series printer. Grayscale printing is not available with **ThinkJet** and **Epson** formats. If you have a color Agilent 54600-series instrument, **DJ Color** format will print in 2 different colors.

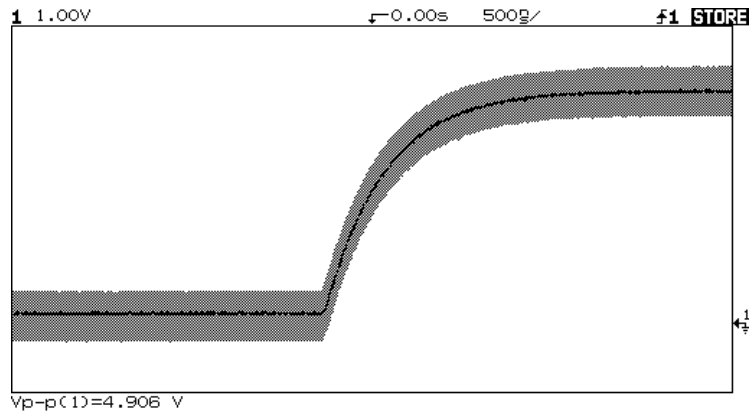

### Gray scale print

### Gray scale plotting

- 1 Press the **Hardcopy Menu** softkey, then press the **Format** softkey until **Plotter** is displayed.



#### Plotting GrayScale from the Plotter Setup menu

Gray scale plotting requires an HP-GL plotter capable of plotting with at least 2 pens.

- 2 Press the **Plotter Setup** softkey, then press the **Colors** softkey until **2** is displayed.  
Gray scale plot uses two pens for the hardcopy. Half-bright traces are plotted with plotter pen 1 and full-bright traces are plotted with plotter pen 2.

## To print or plot scale factors

Instrument scale factors may be turned on or off for hardcopy prints and plots. All factors are printed on the hardcopy when on is selected. When factors is selected for a hardcopy plot, the plot is in portrait mode. When factors is not selected for hardcopy plot, the plot is in landscape mode.

- 1 Press the **Hardcopy Menu** softkey, then press the **Printer Setup** softkey.
- 2 Press the **Factors** softkey until **On** is displayed.

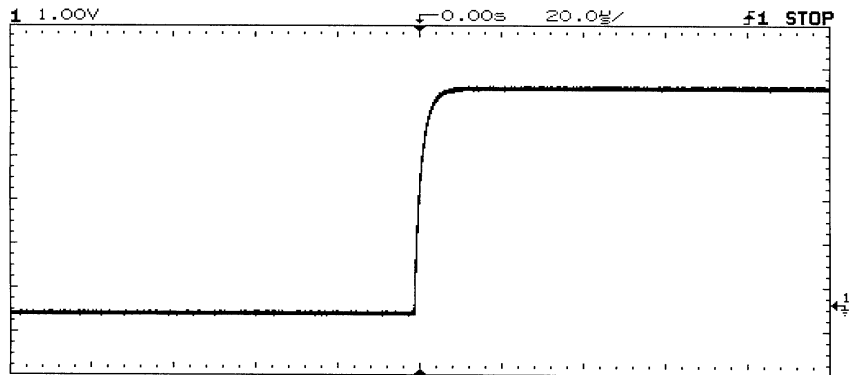

Chan 1	On	1.000 V	-2.366 V	DC	Off	Off	1:1	
Chan 2	Off	100.0mV	0.000 V	DC	Off	Off	1:1	
Chan 3	Off	100.0mV	0.000 V	DC	---	---	1:1	
Chan 4	Off	100.0mV	0.000 V	DC	---	---	1:1	
Horizontal	Mode	Main	Main	Time	Delayed	Delayed		
	Normal	Time/Div	Delay	Ref	Time/Div	Delay		
		20.00us/	0.000 s	Cntr	-----	-----		
Trigger	Mode	Source	Level	Holdoff	Slope	Couplg	Reject	NoiseRej
	AutoLvl	Ch 1	2.366 V	200.0ns	Pos	DC	Off	Off
Display Mode: Normal								

### Print or Plot with Factors On (portrait mode)

I/O Function Guide  
To print or plot scale factors

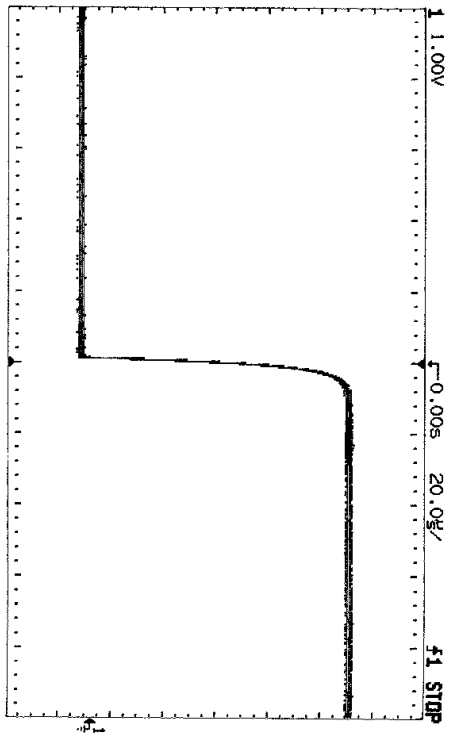

Plot with Factors Off (landscape mode)



---

## To set GPIB addresses

- To set addresses on GPIB modules, press **Print/Utility** , then press the **I/O Menu** softkey.

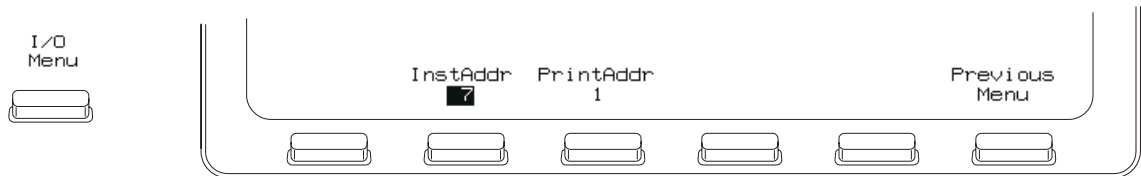

### Setting GPIB addresses

This menu allows you to set the instrument and printer/plotter address. Each device on a GPIB bus must have a unique instrument address between 0 and 30.

#### Instrument address

To set the instrument address, press the **InstAddr** softkey until the correct address is displayed. The address can also be incremented or decremented by turning the knob closest to the **Cursors** key. The default instrument address is 7.

#### Printer Address

To set the printer or plotter address on the GPIB bus, press the **PrintAddr** softkey until the correct address is displayed. The address can also be incremented or decremented by turning the knob closest to the **Cursors** key. The default printer/plotter address is 1.

### See also

For more information on GPIB parameters, refer to the Programmer's Guide that came with your Agilent 54600-Series instrument.

---

## To set RS-232 baud rate and handshake

- To set the baud rate and handshake parameters on a module with an RS-232 interface, press **Print/Utility** , then press the **I/O Menu** softkey.

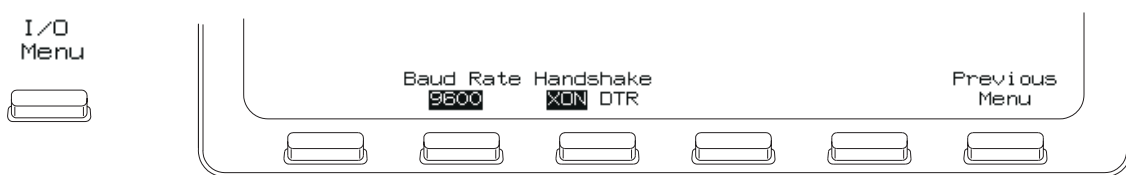

### Setting RS-232-C baud rate and handshake

#### Baud rate

To set the RS-232 baud rate, press the **Baud Rate** softkey until the correct value is displayed. The baud rate can also be incremented or decremented by turning the knob closest to the **Cursors** key. The baud rate can be selected as 1200, 2400, 9600, or 19200. The default baud rate is 9600.

#### Handshake

To set the RS-232 handshake protocol, press the **Handshake** softkey until the correct protocol is displayed.

**Handshake** can be set to **DTR** (data terminal ready) or **XON** (XON-transmit on /XOFF-transmit off.)

#### See also

For more information on RS-232 parameters, refer to the Programmer's Guide that came with your Agilent 54600-Series instrument.

# DECLARATION OF CONFORMITY

according to ISO/IEC Guide 22 and EN 45014

**Manufacturer's Name:** Agilent Technologies  
**Manufacturer's Address:** 1900 Garden of the Gods Road  
Colorado Springs , CO 80901 USA

## Declares, That the product

**Product Name:** Digitizing Oscilloscope Module  
**Model Number(s):** 54652B and 54659B  
**Product Options:** All

## Conforms to the following Product Specifications:

**Safety:** IEC 1010-1:1990 +A1 / EN 61010-1:1993  
UL 3111  
CSA-C22.2 No. 1010.1:1993

**EMC:** CISPR 11:1990 /EN 55011 (1991): Group 1 Class A  
IEC 555-2:1982 + A1:1985 / EN 60555-2:1987  
IEC 555-3:1982 + A1:1990 / EN 60555-3:1983 + A1:1991  
IEC 801-2:1991/EN 50082-1 (1992):4 kV CD, 8 kV AD  
IEC 801-3:1984/EN 50082-1 (1992):3 V/m, {1kHz 80% AM,27-1000MHz}  
IEC 801-4:1988/EN 50082-1 (1992): 0.5 kV Sig. Lines, 1kV Power Lines

## Supplementary Information:

The product herewith complies with the requirements of the Low Voltage Directive 73/23/EEC and the EMC Directive 89/336/EEC, and carries the CE-marking accordingly.

This product was tested in a typical configuration with Agilent Technologies test systems.

Colorado Springs, 1/12/95

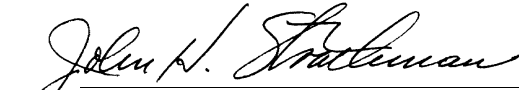
  
John Strathman, Quality Manager

# DECLARATION OF CONFORMITY

according to ISO/IEC Guide 22 and EN 45014

**Manufacturer's Name:** Agilent Technologies  
**Manufacturer's Address:** 1900 Garden of the Gods Road  
Colorado Springs , CO 80901 USA

## Declares, That the product

**Product Name:** Digitizing Oscilloscope Module  
**Model Number(s):** 54655A and 54656A  
**Product Options:** All

## Conforms to the following Product Specifications:

**Safety:** IEC 1010-1:1990 +A1 / EN 61010-1:1993  
UL 3111  
CSA-C22.2 No. 1010.1:1993

**EMC:** CISPR 11:1990 /EN 55011 (1991): Group 1 Class A  
IEC 555-2:1982 + A1:1985 / EN 60555-2:1987  
IEC 555-3:1982 + A1:1990 / EN 60555-3:1983 + A1:1991  
IEC 801-2:1991/EN 50082-1 (1992):4 kV CD, 8 kV AD  
IEC 801-3:1984/EN 50082-1 (1992):3 V/m, {1kHz 80% AM,27-1000MHz}  
IEC 801-4:1988/EN 50082-1 (1992): 0.5 kV Sig. Lines, 1kV Power Lines

## Supplementary Information:

The product herewith complies with the requirements of the Low Voltage Directive 73/23/EEC and the EMC Directive 89/336/EEC, and carries the CE-marking accordingly.

This product was tested in a typical configuration with Agilent Technologies test systems.

Colorado Springs, 1/14/97

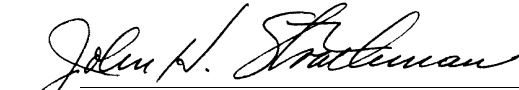
  
John Strathman, Quality Manager

# DECLARATION OF CONFORMITY

according to ISO/IEC Guide 22 and EN 45014

**Manufacturer's Name:** Agilent Technologies  
**Manufacturer's Address:** 1900 Garden of the Gods Road  
Colorado Springs , CO 80901 USA

## Declares, That the product

**Product Name:** Digitizing Oscilloscope Module  
**Model Number(s):** 54657A and 54658A  
**Product Options:** All

## Conforms to the following Product Specifications:

**Safety:** IEC 1010-1:1990 +A1 / EN 61010-1:1993  
UL 3111  
CSA-C22.2 No. 1010.1:1993

**EMC:** CISPR 11:1990 /EN 55011 (1991): Group 1 Class A  
IEC 555-2:1982 + A1:1985 / EN 60555-2:1987  
IEC 555-3:1982 + A1:1990 / EN 60555-3:1983 + A1:1991  
IEC 801-2:1991/EN 50082-1 (1992):4 kV CD, 8 kV AD  
IEC 801-3:1984/EN 50082-1 (1992):3 V/m, {1kHz 80% AM,27-1000MHz}  
IEC 801-4:1988/EN 50082-1 (1992): 0.5 kV Sig. Lines, 1kV Power Lines

## Supplementary Information:

The product herewith complies with the requirements of the Low Voltage Directive 73/23/EEC and the EMC Directive 89/336/EEC, and carries the CE-marking accordingly.

This product was tested in a typical configuration with Agilent Technologies test systems.

Colorado Springs, 4/24/97

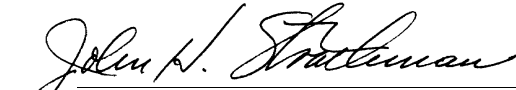
  
John Strathman, Quality Manager



© Copyright Agilent Technologies 1991-1996, 2000 All Rights Reserved.

Reproduction, adaptation, or translation without prior written permission is prohibited, except as allowed under the copyright laws.

### Document Warranty

The information contained in this document is subject to change without notice.

**Agilent Technologies makes no warranty of any kind with regard to this material, including, but not limited to, the implied warranties or merchantability and fitness for a particular purpose.**

Agilent Technologies shall not be liable for errors contained herein or for incidental or consequential damages in connection with the furnishing, performance, or use of this material.

Complete product warranty information is given at the end of this manual.

### Safety

This apparatus has been designed and tested in accordance with IEC Publication 348, Safety Requirements for Measuring Apparatus, and has been supplied in a safe condition. This is a Safety Class I instrument (provided with terminal for protective earthing). Before applying power, verify that the correct safety precautions are taken (see the following warnings). In addition, note the external markings on the instrument that are described under "Safety Symbols."

### Warning

- Before turning on the instrument, you must connect the protective earth terminal of the instrument to the protective conductor of the (mains) power cord. The mains plug shall only be inserted in a socket outlet provided with a protective earth contact. You must not negate the protective action by using an extension cord (power cable) without a protective conductor (grounding). Grounding one conductor of a two-conductor outlet is not sufficient protection.
- Only fuses with the required rated current, voltage, and specified type (normal blow, time delay, etc.) should be used. Do not use repaired fuses or short-circuited fuseholders. To do so could cause a shock of fire hazard.

- Service instructions are for trained service personnel. To avoid dangerous electric shock, do not perform any service unless qualified to do so. Do not attempt internal service or adjustment unless another person, capable of rendering first aid and resuscitation, is present.
- If you energize this instrument by an auto transformer (for voltage reduction), make sure the common terminal is connected to the earth terminal of the power source.
- Whenever it is likely that the ground protection is impaired, you must make the instrument inoperative and secure it against any unintended operation.
- Do not operate the instrument in the presence of flammable gasses or fumes. Operation of any electrical instrument in such an environment constitutes a definite safety hazard.
- Do not install substitute parts or perform any unauthorized modification to the instrument.
- Capacitors inside the instrument may retain a charge even if the instrument is disconnected from its source of supply.
- Use caution when exposing or handling the CRT. Handling or replacing the CRT shall be done only by qualified maintenance personnel.

### Safety Symbols



Instruction manual symbol: the product is marked with this symbol when it is necessary for you to refer to the instruction manual in order to protect against damage to the product.



Hazardous voltage symbol.



Earth terminal symbol: Used to indicate a circuit common connected to grounded chassis.

### WARNING

The Warning sign denotes a hazard. It calls attention to a procedure, practice, or the like, which, if not correctly performed or adhered to, could result in personal injury. Do not proceed beyond a Warning sign until the indicated conditions are fully understood and met.

### CAUTION

The Caution sign denotes a hazard. It calls attention to an operating procedure, practice, or the like, which, if not correctly performed or adhered to, could result in damage to or destruction of part or all of the product. Do not proceed beyond a Caution symbol until the indicated conditions are fully understood or met.

---

## Product Warranty

This Agilent Technologies product has a warranty against defects in material and workmanship for a period of three years from date of shipment. During the warranty period, Agilent Technologies will, at its option, either repair or replace products that prove to be defective.

For warranty service or repair, this product must be returned to a service facility designated by Agilent Technologies.

For products returned to Agilent Technologies for warranty service, the Buyer shall prepay shipping charges to Agilent Technologies and Agilent Technologies shall pay shipping charges to return the product to the Buyer. However, the Buyer shall pay all shipping charges, duties, and taxes for products returned to Agilent Technologies from another country.

Agilent Technologies warrants that its software and firmware designated by Agilent Technologies for use with an instrument will execute its programming instructions when properly installed on that instrument. Agilent Technologies does not warrant that the operation of the instrument software, or firmware will be uninterrupted or error free.

## Limitation of Warranty

The foregoing warranty shall not apply to defects resulting from improper or inadequate maintenance by the Buyer, Buyer-supplied software or interfacing, unauthorized modification or misuse, operation outside of the environmental specifications for the product, or improper site preparation or maintenance.

No other warranty is expressed or implied. Agilent

Technologies specifically disclaims the implied warranties or merchantability and fitness for a particular purpose.

## Exclusive Remedies

The remedies provided herein are the buyer's sole and exclusive remedies. Agilent Technologies shall not be liable for any direct, indirect, special, incidental, or consequential damages, whether based on contract, tort, or any other legal theory.

## Assistance

Product maintenance agreements and other customer assistance agreements are available for Agilent Technologies products.

For any assistance, contact your nearest Agilent Technologies Sales Office.

## Certification

Agilent Technologies certifies that this product met its published specifications at the time of shipment from the factory. Agilent Technologies further certifies that its calibration measurements are traceable to the United States National Institute of Standards and Technology, to the extent allowed by the Institute's calibration facility, and to the calibration facilities of other International Standards Organization members.

## About this edition

This is the the *Interface Modules for Agilent 54600-Series Instruments I/O Function Guide*.

Publication number  
54652-97004

Printed in USA.

Edition dates are as follows:  
54652-97004, August 2000  
54652-97002, July 1996

New editions are complete revisions of the manual. Update packages, which are issued between editions, contain additional and replacement pages to be merged into the manual by you. The dates on the title page change only when a new edition is published.